



Product Catalog

Innovative Products for Women's Health



Company Profile

Founded in 1975, MedGyn manufactures and distributes medical devices for women's healthcare including single use devices, high-quality instruments and equipment for Obstetrics and Gynecology professionals. MedGyn collaborates with physicians and clinical staff worldwide to ensure our products meet and exceed their expectations. With focus on our corporate values, MedGyn has flourished as a leading provider of medical devices globally.

OUR MISSION

Develop trusted products for women's healthcare.

OUR VISION

Drive innovation to improve the quality of health for women worldwide.

OUR VALUES

Commitment to the highest level of service for our customers.

Collaborate with our suppliers, partners, and teammates.

Innovate new products and services to meet our customers' needs.

Grow together as an organization to make an imprint on women's health.

Table of Contents

Colposcopy.....	1
Cryotherapy.....	8
Thermal Ablation.....	10
Electrosurgery.....	11
Fetal Monitoring.....	15
Vacuum Pumps.....	18
Examination Lamp.....	19
Single-Use Gynecology/Oncology.....	20
Single-Use Infertility	22
Single-Use Obstetrics	24
Single-Use Family Planning.....	26
Single-Use General Gynecology.....	32
Pessaries.....	34
Speculums.....	39
Tenaculums.....	44
Biopsy Punches.....	47
Lletz Instruments.....	52
Dilators.....	55
Metal Curettes	59
Forceps	62
Long-Reach Instruments.....	70
Hysterectomy Instruments.....	72
Scissors.....	73
Needle Holders.....	76
Miscellaneous.....	77



GENERAL
GYNECOLOGY



GYNECOLOGY
ONCOLOGY



INFERTILITY



OBSTETRICS



UROGYNECOLOGY



FAMILY
PLANNING



010466SA-HD

010466-HD

MedGyn AL-106 HD™ Digital Video Colposcopes

Different from the traditional optical colposcopes, the AL-106HD™ is a digital colposcope with an LED light source for ultra-bright visualization and a long life cycle. Its unique optical precision and multiple green light filters ensure the highest quality images and improved visualization of blood vessels.

- High-resolution: 1.43M px for AL-106HD, 440K for AL-106
- LED light
- 1-40x magnification
- Ultra-fast auto focus and manual focus option
- Video and image freeze
- Green light filters

- 010466-HD MedGyn AL-106 High Definition Digital Video Colposcope*
- 010466SA-HD MedGyn AL-106 High Definition Digital Video Colposcope with Swing Arm*
- 010010 Colposcope Monitor (Used for AL-101, AL-102, AL-401, AL-105, AL-106)*
- 010490 Colposcope Monitor Stand (Adjustable with Rolling Base)

*Monitor Sold Separately

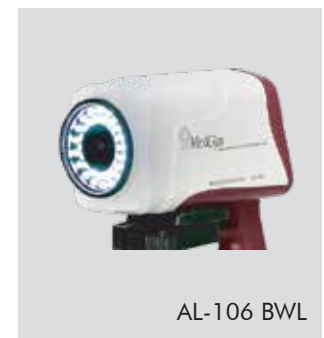

MedGyn AL-106B and AL-106BWL Digital Video Colposcopes

The MedGyn AL-106B™ and AL-106 BWL are more affordable options to the AL-106 HD. The AL-106 BWL is a battery operated colposcope useful in remote areas with limited access to electricity.

- Battery operated and wireless
- High-resolution of 440K pixels
- LED light
- 1-54x magnification (36x for AL-106 BWL)
- Ultra-fast auto focus and manual focus option
- Video and image freeze
- Green light filters

010471 MedGyn AL-106 BWL Digital Video Colposcope, Battery Operated

010469 MedGyn AL-106B Digital Video Colposcope

*Monitor Sold Separately



010500



010505

MedGyn AL-105 and AL-105Z Colposcopes

Traditional optical colposcopes compatible the the MedGyn Image & Data Management Software.

- Five-step magnification 3x, 4x, 7x, 11x, 17x
- LED light source with continuous adjustment
- High-contrast images with excellent stereoscopic effect
- Great depth of field
- Green filters

010505 MedGyn AL-105Z Colposcope with Swing Arm

010500 MedGyn AL-105 Colposcope

AL-105 Accessories

010514 AL-105 Beam Splitter/Adaptor Combined (Single Port)

010515 AL-105 Beam Splitter (Dual Port)

010516 AL-105 Adapter for CCD Camera

010050 AL-105 CCD Camera

010051 AL-105 HDMI CCD Camera

090025 Power Cord #209-000 - UK

090026 Power Cord #199-000 - Europe

090027 Power Cord #364-010 - Italy

090028 Power Cord #456-010 - South Africa



010200



010199

MedGyn AL-102 and AL-101 Colposcopes

MedGyn's classic stereoscopic colposcopes AL-102 and AL-101 are the industry standard. These models combine high-quality lens systems with easy maneuverability at an attractive price.

010200 MedGyn AL-102 Colposcope

- Interchangeable eyepieces, 10x, 13.5x, 18x
- 3-position illumination settings
- Video and camera compatible
- Green filter
- Locking caster wheels

010199 MedGyn AL-101 Colposcope

- 1-step magnification: 16x
- Crystal clear image
- 12.5x eyepieces, 1 fixed and 1 moveable
- Green filter
- Adjustable stand

AL-102 Accessories

010204 AL-102 10x Eyepiece (set of 2)

010205 AL-102 18x Eyepiece (set of 2)

010206 AL-102 13.5x Eyepiece (set of 2)

010209 AL-102 Replacement Bulb

010207 AL-102 Replacement Fuse



MedGyn Image & Data Management Software

Designed for use with our AL-106 series of colposcopes, MedGyn's Image & Data Management Software captures and manages colposcopy images in a self-contained patient record. The user-friendly software includes numerous templates and is easily customizable to your clinic's requirements. The software automatically creates a variety of reports which can include colposcopy images.

- Image annotation and measurement
- Full video capture
- Statistical analysis
- Complete system security, internal password protected
- Includes capture card, security key, and foot switch

010477 MedGyn Image and Data Management Software

010476 MedGyn Image and Data Management Software with Laptop (monitor not included)

010475 MedGyn Image and Data Management Software with Laptop (monitor Included)



030091

MedGyn Colposcopy Set

Everything in one sterile package for an efficient and safe procedure.

030090 Disposable Colposcopy Set

030091 Disposable Colposcopy Set with Rotating Biopsy Punch

030092 Disposable Colposcopy Set with Tischler Biopsy Punch

030093 Disposable Colposcopy Set with Baby Tischler Biopsy Punch



030350

MedGyn Colposcopy Instrument Set

All the instruments you need for a thorough colposcopic examination.

- Tischler Biopsy Punch
- Endocervical Speculum
- Graves Speculum
- Endocervical Curette
- Emmet Hook

030350 MedGyn Colposcopy Instrument Set

MedGyn Single-Use Forceps



029701-D

029701-D Tischler Biopsy Single-Use Forceps, 9 3/4" (10/Pack)



029702-D

029702-D Baby Tischler Biopsy Single-Use Forceps, 9 3/4" (10/Pack)



029703-D

029703-D Kevorkian-Younger Biopsy Single-Use Forceps 9 3/4" (10/Pack)

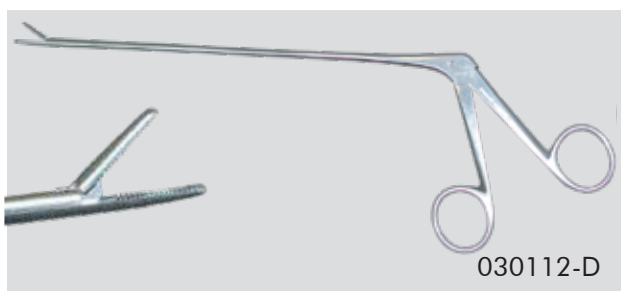

030112-D

030112-D Alligator Single-Use Forceps 8" (10/Pack)



030100-D

MedGyn Rotating Biopsy Forceps

MedGyn's Rotating Biopsy Punch is our latest single-use device with a plastic handle and stainless steel shaft to sample cervical tissue.

030100-D Disposable Rotating Biopsy Forceps



022610

MedGyn Monsel's Solution

Ferric Sub sulfate Solution 20% is an effective hemostatic solution for use after cervical biopsies.

022610 Monsel's Solution - 8mL bottles (12/Box)

022612 Monsel's Solution - 500 mL bottle



MedGyn LED Speculum

MedGyn LED Speculum has a cordless LED light to improve visualization of the exam area.

- 020227 MedGyn Graves/Pederson LED Large (80/Box)
- 020226 MedGyn Graves/Pederson w/ LED Medium (100/Box)
- 020225 MedGyn Graves/Pederson w/ LED Small (100/Box)
- 020227STRL MedGyn Sterile Graves/Pederson w/ LED Large (80/Box)
- 020226STRL MedGyn Sterile Graves/Pederson w/ LED Medium (100/Box)
- 020225STRL MedGyn Sterile Graves/Pederson w/ LED Small (100/Box)



Large



Medium



Small



MedGyn Vaginal Speculum (Non-Sterile)

MedGyn Disposable Speculum is available in both Graves and Pederson styles and easily locks in a variety of positions to reduce examination time.

- 020205 MedGyn Disposable Graves Large (100/Box)
- 020204 MedGyn Disposable Graves Medium (100/Box)
- 020201 MedGyn Disposable Pederson Small (100/Box)



Large



Medium



Small



022732



MedGyn Endocervical Curette

The MedGyn Endocervical Curette provides an efficient sampling of the cervical canal to test for abnormal, precancerous conditions, or cervical cancer.

- The Kevorkian-Younger endocervical curette is a sterile, single-use device with a basket and a square tip.

022732 MedGyn Disposable Endocervical Curette (25/Box)



019019



019000

MedGyn MGC-200 Cryotherapy System

The MedGyn Cryotherapy System is designed by physicians and engineered by cryogenic experts to ensure safety, performance, and convenience. The 3-position single trigger delivers optimal cryosurgical temperatures with Nitrous Oxide (N₂O) or Carbon Dioxide (CO₂) gas. The system has standard-specific adaptors and a wide variety of autoclavable tips available.

- Single-hand control with 3 settings: freeze, off, and defrost
- Instant defrost
- Change tips without shutting off the gas
- Built-in regulators control pressure at tip for added safety and gas economy

019000 MedGyn Cryotherapy System MGC-200 (tips not included)

Cryotherapy Equipment & Accessories

- | | | | |
|--------|---|--------|---|
| 019001 | Cart for Cylinder, 6lb or 20lb | 019016 | French Adapter For N ₂ O |
| 019003 | "O" Ring for Cryo System (3/pack) | 019017 | US adapter for N ₂ O (6lb) |
| 019008 | French Adapter for CO ₂ | 019018 | US adapter for CO ₂ (6lb) |
| 019009 | German Adapter for CO ₂ | 019019 | Carrying Case for Cryotherapy System |
| 019012 | German Adapter for N ₂ O | 019020 | Protective Cap for Cryotherapy System |
| 019010 | British Adapter for CO ₂ | 019021 | Rubber Plug 6448K92 for MedGyn Cryo Tip |
| 019011 | British Adapter for N ₂ O | 019022 | Plastic Probe Protection Bag |
| 019013 | US Adapter for N ₂ O (20 lb) | 019030 | 450 Purifier Housing with 1/4 npt Male Thread Adapter |
| 019014 | US Adapter for CO ₂ (20lb) | 019031 | 451 Filter Cartridge for Purifier |
| 019015 | Chinese Adapter for CO ₂ | | |



019017



019013



019016

MedGyn Cryotherapy Tips

Safe, interchangeable, autoclavable tips are made from a conductive gold alloy, resulting in very rapid freeze and defrost capabilities. Designed to allow for change-out without the need to shut off gas flow, reducing risk of blown "O" ring.



019002/2507 Cryotherapy Tip GT-2507 Endo/Exocervical, Large



019002/2500 Cryotherapy Tip Tip GT-2500 Exocervical, 25mm Flat



019002/1910 Cryotherapy Tip Tip GT-1910 Endo/Exocervical, Small



019002/1905 Cryotherapy Tip GT-1905 Exocervical, Convex (19mm X 5mm)



019002/1900 Cryotherapy Tip GT-1900 Exocervical, 19mm Flat



019002/0811 Cryotherapy Tip GT-0811 Skin Lesion, 8mm Diam, 45° angle



019002/0800 Cryotherapy Tip GT-0800 Endocervical, Round



019002/0519 Cryotherapy Tip GT-0519 Endocervical, Nulliparous



019002/0507 Cryotherapy Tip GT-0507 Skin Lesion, 5mm Diam, 45° angle



019002/0219 Cryotherapy Tip GT-0219 Micro, 2mm Diam



019002/0832 Cryotherapy Tip GT-0832 Anorectal

MedGyn MTA-100 Thermal Ablation System

In 2019, WHO issued new guidelines for the use of thermal ablation for cervical precancer lesions. While they continue to recommend cryotherapy, the WHO has offered thermal ablation as an alternative method of treatment for specific environments. MedGyn is pleased to announce its latest device: MedGyn's MTA-100 Thermal Ablation System. The device is a portable, lightweight device for the treatment of pre-cancerous lesions optimized for 20, 40, or 60 second intervals of treatment.





018003

- Optimized to offer 20, 40, or 60 second intervals for procedure
- Bright LED lights for clear viewing of cervical area.
- Sound and light activation for beginning and end of procedure.
- Digital display to detailing temperature at all stages of procedure
- Durable and ergonomic handle for ease of use
- 25mm tip available offering larger treatment area

MedGyn MTA-100 Tips

Safe, interchangeable, autoclavable tips are made from a conductive gold alloy, to allow for various precancerous lesion treatment sizes.

	018003/2500 Exocervical, 25mm, Flat
	018003/2507 Endo/Exocervical, Large
	018003/1910 Endo/Exocervical, Small
	018003/1905 Exocervical, Convex, 19mm x 5mm
	018003/1900 Exocervical, 19mm, Flat

018003 MedGyn MTA-100 Thermal Ablation System * Patented

018003-CS Thermal Ablation System Case

018003-RB Thermal Ablation System Rechargeable Battery

018003-BC Thermal Ablation System Rechargeable Battery Charger

019022 Plastic Probe Protection Bag



MedGyn ElectroSurgical Generators (ES Series)

The MedGyn ES-100, ES-200, ES-300, ES-400 ElectroSurgical Generator Series meet all demands for a LEEP/ LLETZ procedure. MedGyn's generators feature both monopolar and bipolar functions to satisfy all surgical demands with safety, flexibility, reliability, and convenience.

- Pure cut and blend cut functions
- Contact coagulation and bipolar coagulation
- Displays output power digitally
- Allows operator to check output power easily during the procedure
- Power source: AC120V or AC230V, 50/60 Hz (manual switch)

- 018015** MedGyn ES-100: ElectroSurgical Generator (110-230V)
(Includes Single Foot Switch, Disposable Twin Button Handle, Silicone Patient Plate)
- 018120** MedGyn ES-200: ElectroSurgical Generator (220V)
(Includes Single and Double Foot Switch, Disposable Twin Button Handle, Silicone Patient Plate)
- 018130** MedGyn ES-300: ElectroSurgical Generator (220V)
(Includes Single and Double Foot Switch, Disposable Twin Button Handle, Silicone Patient Plate)
- 018135** MedGyn ES-400: ElectroSurgical Generator (220V)
(Includes Single and Double Foot Switch, Disposable Twin Button Handle, Silicone Patient Plate)

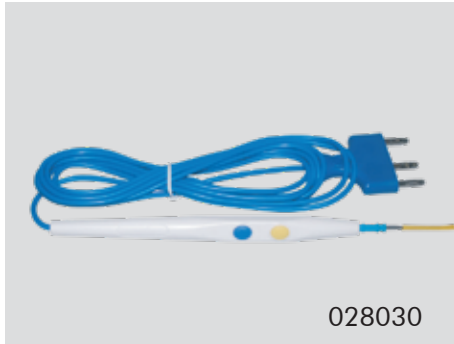

028030



028032



028033

- 028030 Disposable Handswitch Pencil Single Use (10/Pack)
- 028032 Handswitch Pencil Reusable
- 028033 Disposable Grounding Pad with Cable
- 028031 Disposable Grounding Pads without Cable
- 028034 Reusable Cable Only for Disposable Grounding Pad

Accessories for Electrosurgical Generators

- FS02-01R Double Foot Switch - 4Pin Plug Cable 4m
- FS01-02R Single Foot Switch - 3Pin Plug Cable 4m
- HD02-01D Disposable Twin Button Handle - 3Pin Plug Cable 3m
- HD01-01R Mono Polar Handle & Cable - Silicon Cable 4ø 3m For ES-200/300/400
- HD01-02R Mono Polar Handle & Cable - Silicon Cable 4ø 3m For ES-100
- PL02-04R Silicon Patient Plate - 240mm x 150mm Valley Lab Type Plug Cable 3m
- PL03-02D Disposable Patient Plate (2ea) - Adult Dual (120cm²) For ES-200/300/400
- PL03-03D Disposable Patient Plate (2ea) - Adult Dual (68cm²) For ES-100
- CA02-02R Patient Return Plate Cable - 6.3 Pie Plug Silicon Cable 3m For ES-100
- CA02-03R Patient Return Plate Cable - Valley Lab Type Plug Silicon Cable 3m For ES-200/300/400
- CA03-01R Ground Cable - Cable 4ø, 3m
- CA01-01R Bipolar Forceps Cable - 2pin Plug Cable 3mEN Type Connector
- BF01-01R Bipolar Forceps - Bayonet 17.8cm 1.0 Tip
- EL01-02D Electrode - Knife 2.4 * 70mm Black
- EL02-02D Electrode - Ball 5mm Black
- EL03-02D Electrode - Loop 6mm Black
- EL04-02D Electrode - Needle 2.4 * 70mm Black
- EL04-04D Electrode - Needle Angled 45° 2.4 * 70mm, Black
- ST03-01R Latex Strap Perforated - 600mm x 1250mm, 60 hole
- PL03-03D Disposable Patient Plate - Pediatric Dual (66cm²)
- BF01-02R Bipolar Forceps - Bayonet 15.2cm 1.0 Tip
- BF02-01R Bipolar Forceps - Straight 9.0cm 0.5 Tip
- BF02-02R Bipolar Forceps - Straight 12.1cm 1.0 Tip
- BF02-03R Bipolar Forceps - Straight 17.8cm 1.0 Tip
- BF03-01R Bipolar Forceps - Angled 9.0cm 0.5 Tip
- BF03-02R Bipolar Forceps - Angled 17.8cm 1.0 Tip
- CT01-01R Cart - W390xD480xH850(mm)

MedGyn Disposable Electrodes

Made of high-quality tungsten wire, for superior shape and integrity, MedGyn offers a full range of shapes and sizes to suit most electrosurgical procedures.

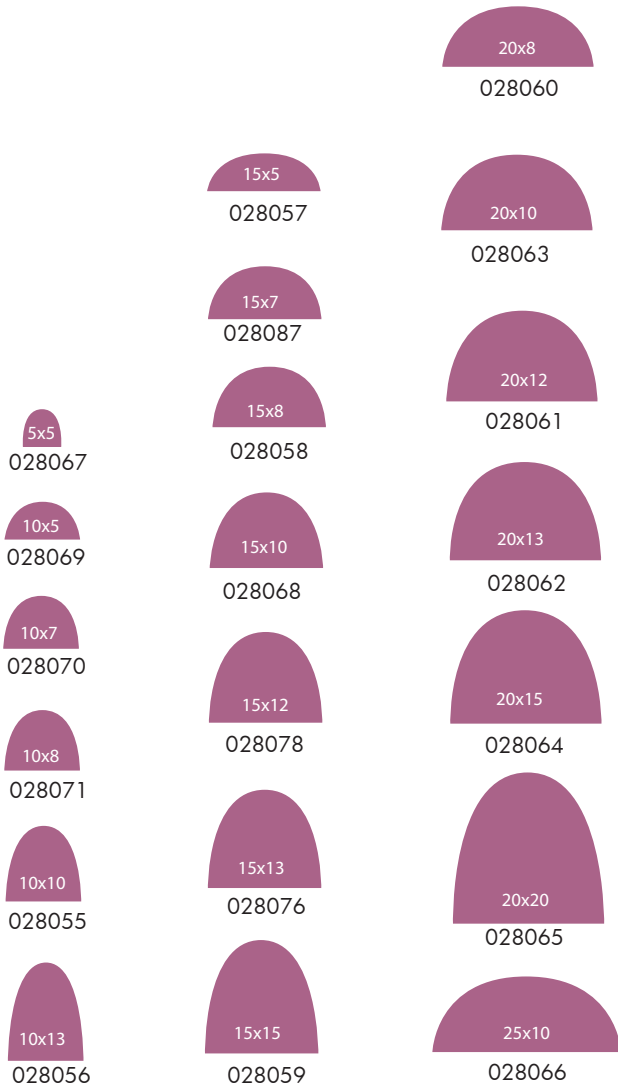

- 028067 Disposable Loop Electrode 5mm x 5mm (5/Pack)
- 028069 Disposable Loop Electrode 10mm x 5mm (5/Pack)
- 028070 Disposable Loop Electrode 10mm x 7mm (5/Pack)
- 028071 Disposable Loop Electrode 10mm x 8mm (5/Pack)
- 028055 Disposable Loop Electrode 10mm x 10mm (5/Pack)
- 028056 Disposable Loop Electrode 10mm x 13mm (5/Pack)
- 028057 Disposable Loop Electrode 15mm x 5mm (5/Pack)
- 028087 Disposable Loop Electrode 15mm X 7mm (5/Pack)
- 028058 Disposable Loop Electrode 15mm x 8mm (5/Pack)
- 028068 Disposable Loop Electrode 15mm x 10mm (5/Pack)
- 028078 Disposable Loop Electrode 15mm x 12mm (5/Pack)
- 028076 Disposable Loop Electrode 15mm x 13mm (5/Pack)
- 028059 Disposable Loop Electrode 15mm x 15mm (5/Pack)
- 028060 Disposable Loop Electrode 20mm x 8mm (5/Pack)
- 028063 Disposable Loop Electrode 20mm x 10mm (5/Pack)
- 028061 Disposable Loop Electrode 20mm x 12mm (5/Pack)
- 028062 Disposable Loop Electrode 20mm x 13mm (5/Pack)
- 028064 Disposable Loop Electrode 20mm x 15mm (5/Pack)
- 028065 Disposable Loop Electrode 20mm x 20mm (5/Pack)
- 028066 Disposable Loop Electrode 25mm x 10mm (5/Pack)

- 028041 Disposable Ball Electrode 3mm (5/Pack)
- 028042 Disposable Ball Electrode 5mm (5/Pack)
- 028081 Disposable Blade Electrode (5/Pack)
- 028053 Disposable Needle 5mm (5/Pack)

- 028075 Disposable Square Loop Electrode 5mm x 5mm (5/Pack)
- 028072 Disposable Square Loop Electrode 10mm x 4mm (5/Pack)
- 028073 Disposable Square Loop Electrode 10mm x 8mm (5/Pack)
- 028074 Disposable Square Loop Electrode 10mm x 10mm (5/Pack)



MedGyn Electrosurgical Generator System

MedGyn Electrosurgical Generator Complete System includes the ES Generator, Smoke Evacuator, and trolley.

- 018011 MedGyn Electrosurgical Generator Complete System includes the ES Generator, Smoke Evacuator, and Trolley
- 018102 MedGyn Electrosurgical Generator Trolley



018011

MedGyn Smoke Evacuators

Smoke filtration system minimizes airborne microbes and viruses while removing smoke from site for improved visualization for use during all electrosurgical procedures.

- 018100 MedGyn Smoke Evacuator (110V)
- 018109M MedGyn Smoke Evacuator System SA-01 (220V)
- 018109 MedGyn Smoke Evacuator System (220V)



018100

Smoke Evacuator Accessories

- 018105 Smoke Filter Tube for MedGyn Smoke Evacuator (Single use, Sterile - 110V or 220V) (5/Box)
- 018106 Disposable Smoke Evacuator (DSE) Male tubing 8" (Non-Sterile) (50/Box)



018109



017118



017122

MedGyn Fetal Monitors – "F" Series

MedGyn's F6 & F9 Fetal and Maternal Monitor series combine simultaneous mother and baby monitoring. These monitors offer powerful patient information management and centralized monitoring system compatibility with a color display.

- 10.2" foldable wide color screen
- 24-hour CTG storage
- Built-in thermal array printer
- Data management software for real-time data transmission to PC
- Intrapartum monitoring (DECG/IUP) (Optional)
- The F6 Express offers the same superior features as the F6 System but with maternal monitoring included

017118 MedGyn F6 Fetal Monitor (FM10)

017119 MedGyn F6 Fetal Monitor (FM10) Twin FHR

017120 MedGyn F6 Express Fetal Monitor (FM10)

The F9 Fetal Monitor offers the same superior features as the F6 Fetal Monitor plus a foldable 12" color screen

017122 MedGyn F9 Fetal Monitor

017123 MedGyn F9 Express Fetal Monitor

Fetal Monitor Accessories

017105 Strap for Fetal Monitor F6

017106 Battery for Fetal Monitor F6

017191 Recording Paper for Fetal Monitor F6

017192 Recording Paper for Fetal Monitor F9

017125 Fetal Monitor Stand (Adjustable with Rolling Base)

MedGyn Ultrasonic Pocket Doppler

MedGyn Pocket Doppler combines reliable and accurate detection with easy-to-use, light-weight design. Available with rechargeable batteries and probe frequency options.

- Easy-to-read, back-lit LCD display
- Built-in recorder
- Accurate FHR detection with sound
- Automatic and manual FHR counting
- Interchangeable waterproof probes



017101

017101 Ultrasonic Pocket Doppler with 2MHz Probe

017126 Ultrasonic Pocket Doppler with 3MHz Probe

017102 Ultrasonic Pocket Doppler with 2MHz Probe Rechargeable

017127 Ultrasonic Pocket Doppler with 3MHz Probe Rechargeable

017100 MedGyn Ultrasonic Pocket Doppler (2MHz Probe)



017100

Ultrasonic Pocket Doppler Accessories

017128 2MHz Probe

017129 3MHz Probe

017130 4 MHz Probe

017132 5 MHz Probe

017131 8 MHz Probe

MedGyn Ultrasonic Table-Top Doppler

MedGyn Table-Top Dopplers are innovative additions to our Doppler category in a portable, light-weight package. Available in both wireless/infrared and wired models.

- Easy-to-read, back-lit LCD display
- Built-in recorder
- Accurate FHR calculation
- Portable lightweight design



SD5 Table-Top Doppler (Wired)

017150

017150 SD5 Table-Top Doppler with 2MHz probe, wired

017151 SD6 Table-Top Doppler with 2MHz probe, wireless



SD6 Table-Top Doppler (Wireless)

017151

Ultrasonic Table-Top Doppler Accessories

017155 2MHz Probe, Wired for SD5

017157 3MHz Probe, Wired for SD5

017156 2MHz Probe, Wireless for SD6

017158 3MHz Probe, Wireless for SD6

017159 Carry Bag for SD5/SD6

017160 Rolling Stand for SD5/SD6

017199 Doppler Gel 8oz



015090

Eco 3 Ultrasound

- 12" LED Monitor, 2 Probe Connectors, 3.5MHz Convex Probe
- Ergonomic Shape
- USB Connection
- THI (Tissue-Harmonic Imaging)
- SRA (Speckle-Reduction Algorithm)

015090 Eco 3 Ultrasound System

Eco3 Ultrasound Accessories

- 015091 3.5MHz Convex Probe C3-A for Eco-3
- 015092 5.3 - 10.0 MHz Linear Probe L7M-A for Eco-3
- 015093 5.3 - 11.0 MHz Linear Probe L7S-A for Eco-3
- 015094 3.0MHz Phased Array Probe P3-A for Eco-3
- 015095 6.0MHz Trans-vaginal Probe V6-A for Eco-3
- 015096 7.5MHz Trans-rectal Probe R7-A for Eco-3
- 015097 6.0MHz Micro-convex Probe (Pediatrics) MC6-A for Eco-3
- 015098 3.0MHz Micro-convex Probe MC3-A for Eco-3
- 015099 5.0MHz Micro-convex Probe MC5V-A for Eco-3
- 015100 DICOM for Eco-3
- 015010 Ultrasound Cart



040065

Other

- 010004 Sony Video Printer
- 040065 Video Print Paper - 110mm x 20mm rolls (10/Box)

MedGyn Senator Vacuum Pump

Senator Vacuum Pump is made of high-quality components and with Swiss mechanical precision to guarantee excellent functionality. The Senator Vacuum Pump is ideal for removal of secretions, vacuum extractions, uterine suctions and for pleural drainage.

- Suction capacity of 30 L/min
- Suction strength can be adjusted continuously and precisely
- Compact and user-friendly pump with large, integrated recessed grip
- Reliable 3-guard protective system with float levers integrated in bottle lids and hydrophobic bacterial filter

016100 Senator Vacuum Pump (Accessories and Trolley Sold Separately)

016150 Senator Vacuum Pump System (Includes Footswitch, Trolley) 110 Volt Only

016101 Hydrophobic Filter



016150



016100

MedGyn MVP-100 Vacuum Pump

MedGyn MVP-100 Vacuum Pump is designed for safety and convenience. It features a push-switch linked directly to the pump and a trap bottle to control overflow.

- Applied oil-less piston vacuum pump
- Two collection bottles of 3,000 cc each
- Built-in anti-overflow device
- Push-switch (red button) linked directly to pump for ease of checking pump status
- Control low-voltage for user safety (under DC 12v)

016155 MedGyn MVP-100: Vacuum Pump (Includes Foot Switch, Collection Bottle)



016155

MedGyn Portable Vacuum Pump

- Oil-less piston requiring no lubrication and no maintenance
- 1000 mL autoclavable collection jar
- 12V rechargeable battery for two hours of operation

016156 MedGyn Portable Vacuum Pump

022316 Suction Tube 2m for MedGyn Portable Pump

022321 Suction Filter with Side Tube for MedGyn Portable Pump

022322 Suction Bottle with Bottle Cap for MedGyn Portable Pump



016156



MedGyn LED-100 Examination Lamp

MedGyn LED-100 Examination Lamp is used to assist in performing clinical and gynecological exams. The Lamp has a flexible, chrome-plated, top base with four casters for excellent maneuverability and stability. The LED-100 provides three times better light output than standard lamps with exceptional longevity and brightness

- Highly flexible LED light is easy to maneuver
- True tissue color rendition and pinpoint accuracy
- Power dual voltage 110V or 240V, 60/50Hz
- Illuminance of 20,000 lux (Distance of 50 cm)
- Minimum expected life of LED is 35,000 hours
- Net weight: 5 kg (10.2 lb)
- Variable height of 110cm and 150 cm (95.5lb x 130lb)
- Electrical Standards: NBR-IEC 60.601-1 and NBR-IEC 60.601-1-2

010551 MedGyn LED-100 Examination Lamp
(Includes Rolling base with 4 Casters)

MedGyn Endosampler™

The unique design of the MedGyn Endosampler™ allows for superior accuracy and a more reliable sample. Available with one or two holes for the right amount of suction for each patient.

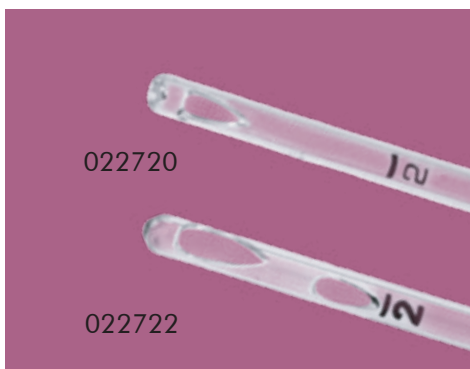

- 3mm curette and 10cc syringe
- Highly-visible graduated markings
- Semi-rigid curette
- Curved for improved manipulation
- Prevent back-flow with syringe lock-spring
- Sharp slot in curette tip
- "Closed" system prevents sample contamination

022720 MedGyn Endosampler™ (25/Box)

022722 MedGyn EndosamplerII™ (25/Box)

MedGyn Pipette™

The MedGyn Pipette™ and Pipette IV™ are unique, sterile, disposable cannulas for sampling the endometrium.

- Semi-rigid and tapered for easy insertion and safety
- Flexible enough collect tissue from all areas

022721 MedGyn Pipette 3.1mm O.D. (25/box)

022730 MedGyn Pipette IV 3.1mm O.D. (25/box)



MedGyn Mucous Sampler

The MedGyn Mucous Sampler is a single-use, sterile, endocervical aspirator.

- 23 cm long, clear, flexible polypropylene tube
- 2.2mm diameter circular opening
- Distal end rounded for safety

022729 MedGyn Disposable Mucous Sampler (25/pack)



MedGyn Cell Sweep®

The MedGyn Cell Sweep® makes pap smears easier than ever by simultaneously sampling both the endocervix and ectocervix, eliminating the need for both a cytobrush and spatula.

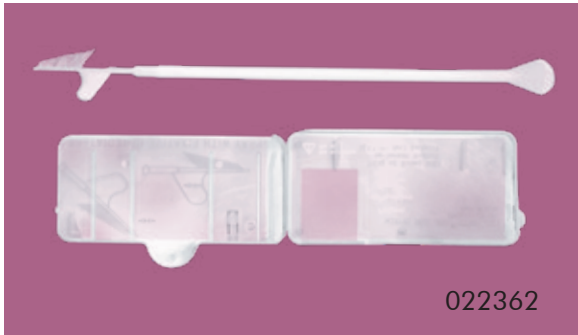

022362



022363

- 022362 MedGyn Cell Sweep® Slide Holder (100/pack)
- 022361 MedGyn Cell Sweep® Non-Sterile (100/pack)
- 022361K MedGyn Cell Sweep® Non-Sterile with Kit (Slide and Slide Holder) (100/pack)
- 022363 MedGyn Cell Sweep® Sterile (100/pack)
- 022363K MedGyn Cell Sweep® Sterile with Kit (Slide and Slide Holder) (100/pack)

MedGyn Cytobrush and Pap Cell

- 022710 MedGyn Cytobrush (100/Box)
- 022364 MedGyn Pap Cell (50/Box)



022710



022364

MedGyn HSG Catheters

MedGyn HSG Catheter is used to inject contrast media or saline into the uterus and fallopian tubes for hysterosalpingography and sonohysterography procedures. It has a latex-free balloon catheter with a rigid insertion sheath.

022726 MedGyn HSG Catheters - 5Fr (10/Box)

022728 MedGyn HSG Catheters - 7Fr (10/Box)

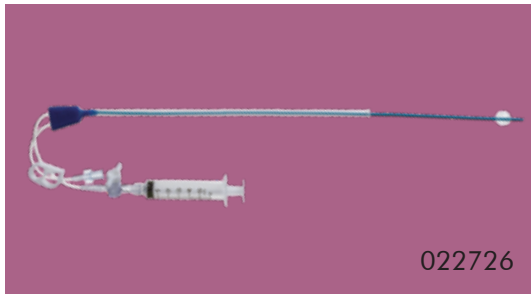

022726

MedGyn EZ Inject Catheter

A simple and effective way to allow visibility of the uterine cavity.

- Balloonless catheter allows for a more complete view
- Long tip at distal end improves placement in the cervical canal

022797 MedGyn EZ Inject Catheter with 10/cc Syringe (10/box)



022797

MedGyn IUI Catheters

MedGyn Insemination Catheter is a sterile, flexible catheter designed for use in intrauterine insemination. Tip of catheter is rounded and beveled for patient comfort.

022723 MedGyn Intrauterine Insemination Catheter - Regular/Straight (25/Box)

022724 MedGyn Intrauterine Insemination Catheter - Mini (25/Box)

022725 MedGyn Intrauterine Insemination Catheter - Curved (25/Box)



022723

022724

022725



022723

MedGyn Intrauterine Insemination Kit

MedGyn's Intrauterine Insemination Kit includes all components necessary for infertility procedures.

022799 MedGyn Insemination Kit (Endosampler, IUI's, Pipette, OS Finder, LED Speculum, HS Catheter)



022800 MedGyn Insemination Kit (Endosampler, IUI's, Pipette, OS Finder, LED Speculum, EZ Inject Catheter)





022699

MedGyn Follicle Aspiration Needle

Our Follicle Aspiration Needle is used to harvest ovarian tissue, as well as flush oocytes from the follicles.

- Used for ultrasound-guided transvaginal harvesting of oocytes from follicles
- Internal surface of the needle and tubing are extremely smooth which allows safe transfer of egg to test tube
- Enabled flushing of needle and connecting tube after the procedure
- Single lumen

022699 MedGyn Follicle Aspiration Needle



022697

MedGyn Vitrification Straws

The MedGyn Vitrification Straws are cryopreservation storage devices utilized in the vitrification procedure to contain and maintain oocytes and embryos.

- Provide reliable oocyte and embryo vitrification
- Straws have great durability and endurance while stored in a liquid nitrogen tank
- Minimal storage space is needed while allowing the maximum quantity of straws in the tank

022697 MedGyn Vitrification Straws

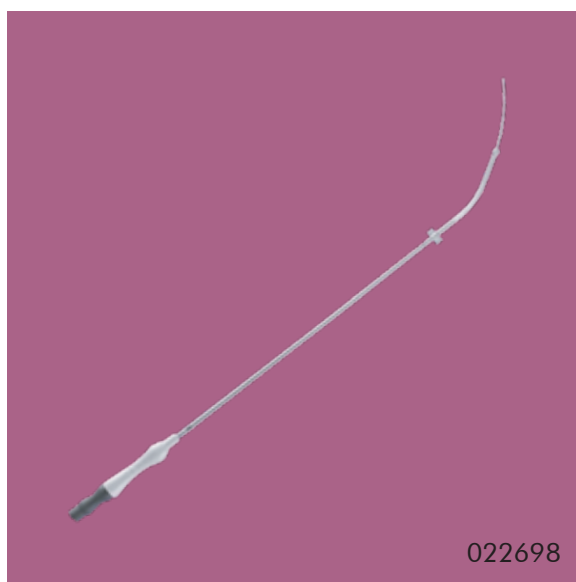

022698

MedGyn Embryo Transfer Catheter

The Embryo Transfer Catheter is used to place in vitro fertilized (IVF) embryos into the uterine cavity. The single, plastic catheter is loaded with the embryo and smoothly introduced through the cervical canal up to 1 – 2cm from the uterine fundus, while trying to avoid touching the fundus under ultrasound guidance. Length of Embryo Transfer Catheter is 18 to 23cm.

- Guide catheter is curved to facilitate insertion
- Guide catheter's rounded bulb tip eases passage through the cervix.
- Transfer catheter is soft and flexible.
- The cervical stop comes set at 4 cm and can be adjusted to 5 cm.
- Catheters are packaged in separate sterile pouches.

022698 MedGyn Embryo Transfer Catheter

MedGyn Pregnancy Test Kits

MedGyn One-Step Pregnancy Test Kit is an easy-to-use clinical pregnancy test that delivers fast and accurate results. Our tests have built-in test controls and highly visible color.

- 022704 MedGyn Pregnancy HCG Cassette Urine Test (25/Box)
- 022705 MedGyn Pregnancy HCG Combo Urine/Serum Test (25/Box)
- 022706 MedGyn Pregnancy HCG Dipstick Urine Test (25/Box)



022704

MedGyn Amnio Hook

MedGyn Amnio Hook is designed to perforate the amniotic membrane with a rigid talon tip.

- 020301 MedGyn Disposable Amnio Hook (50/Pack)



020301

MedGyn Umbilical Cord Clamp

MedGyn Umbilical Cord Clamp has grooved clamping and lock to secure the umbilical cord prior to cutting.

- 020302 MedGyn Disposable Umbilical Cord Clamp (100/Pack)



020302

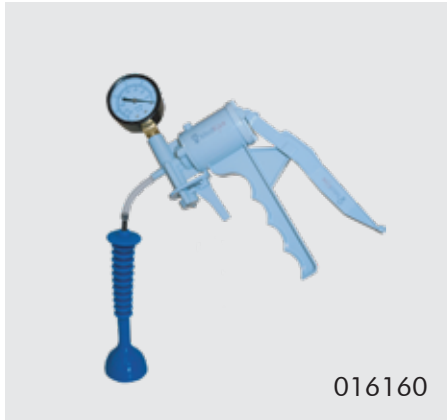

016160



020322



020320

MedGyn HVP-100 Hand-Held Vacuum Delivery Pump and Vacuum Assisted Delivery Cups

MedGyn Hand-Held Vacuum Delivery Pump may be used to safely assist medical personnel during vaginal deliveries. MedGyn Vacuum Delivery Cups offer optimal adhesion to ensure proper vacuum levels.

- 016160 MedGyn HVP-100 Hand-Held Vacuum Delivery Pump
- 020322 MedGyn Vacuum Delivery Cups 50mm with Release Valve
- 020323 MedGyn Vacuum Delivery Cups 60mm with Release Valve
- 020316 MedGyn Vacuum Delivery Cups 70mm with Release Valve
- 020320 Vacuum Delivery Cup 50mm
- 020321 Vacuum Delivery Cup 60mm

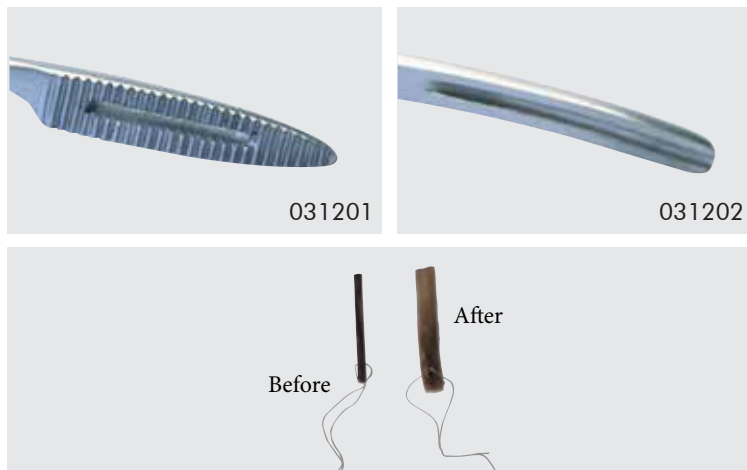
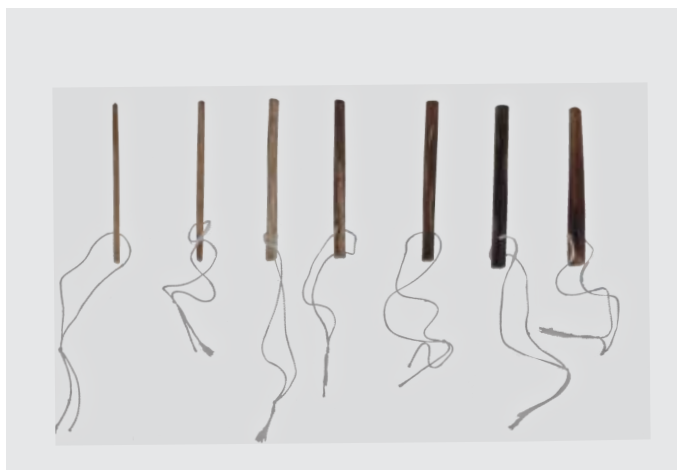

MedGyn Laminaria

Laminaria (type of hygroscopic dilator) is a 100% natural sterile cervical dilator made from a sea-grown plant containing no synthetic materials. Safely utilized for over a century, Laminaria provides gentle, gradual dilation. After harvesting, the plant is dehydrated. Once inserted into the cervical canal, Laminaria absorbs liquid, swelling to several times its initial dried diameter, gently dilating the cervix.

Standard, Approximate Length 60mm

- 021002 2mm Extra Small/Extra Thin (25/Box)
- 021003 3mm Small (25/Box)
- 021004 4mm Medium (25/Box)
- 021005 5mm Large/Thick (25/Box)
- 021006 6mm Extra Large/Extra Thick (25/Box)
- 021008 8mm Jumbo (25/Box)
- 021010 10mm Extra Jumbo (25/Box)

Extra Long, Approximate Length 70mm

- 021014 4mm Long 70mm (25/Box)
- 021015 5mm Long 70mm (25/Box)
- 021016 6mm Long 70mm (25/Box)
- 021018 8mm Long 70mm (25/Box)

Long String

- 021003L Laminaria #3 Long-String
- 021004L Laminaria #4 Long-String
- 021005L Laminaria #5 Long-String
- 021006L Laminaria #6 Long-String
- 021008L Laminaria #8 Long-String

With Buttons to Prevent Over Insertion

- 021022 2mm Extra Small with Buttons (12/Box)
- 021023 3mm Small with Buttons (12/Box)
- 021024 4mm Medium with Buttons (12/Box)
- 021025 5mm Large with Buttons (12/Box)
- 021026 6mm Extra Large with Buttons (12/Box)

Laminaria D

- 021033 MedGyn Laminaria D, size 3mm
- 021034 MedGyn Laminaria D, size 4mm
- 021035 MedGyn Laminaria D, size 5mm

Laminaria Inserter

- 031201 MedGyn Laminaria Inserter
- 031202 McMahon Laminaria Inserter



022310



022331

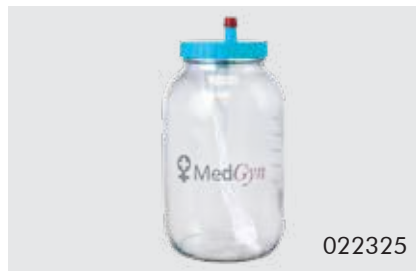

022325



022450



022352



022343



022340



022341

MedGyn Collection Sets, Collection Jars and Bags

MedGyn Disposable Collection Sets include 6' tubing (either 3/8" or 1/2" I.D.) attached to a control handle with slip-ring for finger-tip vacuum control. The Collection Sets are individually packaged and sterile.

Collection Sets & Bottles

- 022310 3/8" Collection Set with Handle (50/Pack)
- 022310NS 3/8" Collection Set w/Handle & Adapter (Non-Sterile)
- 022310-WO 3/8" Collection Set with Handle (Without Adapter, Sterile) (50/Pack)
- 022314 3/8" Collection Set x 8 Ft with Handle & Adaptor
- 022312 1/2" Collection Set with Handle & Adapter (25/Pack)
- 022312NS 1/2" Collection Set w/Handle & Adapter (Non-Sterile)
- 022331 3/8" Disp. Collection Jar - with Cap (10/Box)
- 022332 1/2" Disp. Collection Jar - with Cap (10/Box)
- 022323 Disp. Tops Large Non-Conductive (10/Box)
- 022324 Disp. Tops Small Non-Conductive (10/Box)
- 022325 Glass Collection Jar - 1400mL

Metal Swivel Handles

Stainless steel, autoclavable, with slip-ring control

- 022450 3/8" Handle for Curettes up to 14mm with small base
- 022451 1/2" Handle for 14mm, 15mm & 16mm Curettes
- 022340 Stainless Steel 3/8" Female Fitting
- 022341 Stainless Steel 3/8" Male Fitting
- 022343 Stainless Steel 1/2" Male Fitting
- 022352 Stainless Steel 3/8" Handle Extender
- 022353 Stainless Steel 1/2" Handle Extender
- ADAP-REDC 1/2" to 3/8" Adapter for Aspiration Handle (For Small Curette) (10Box)
- 022354 3/8" to 1/2" Adapter for Aspiration Handle (For Large Curette)

Non-Sterile Accessories

- 022316-3/8-6 Tubing 3/8" Precut to 6'
- 022311 Tubing 3/8", Custom Cut Per Foot
- 022316-1/2-6 Tubing 1/2" Precut to 6'
- 022313 Tubing 1/2", Custom Cut Per Foot
- 022317 Tubing 16" Connector
- 022318 Tubing 20" Connector
- 022317-ADAP Tube Fitting - Male 3/8" Plastic
- 022317-INT Tube - Interconnecting with Adapter (10/Box)
- 022319-ADAP Tube Fitting - Male 1/2" Plastic
- 022350 Plastic Adapter for 1/2" Base Curettes (Sterile)
- 022351 Plastic Adapter for 1/2" Base Curettes (Non-Sterile)
- O-RING-FAD 3/8" O Ring for Female Adapter (10/Pack)
- 022320 Disposable Filter Assembly (10/Box)

Permeable Gauze Sacks

Gauze collection sack easily attaches to collection canister for simple and efficient separation of tissue from aspirated fluid.

- 022460 Gauze Sacks Tissue Trap (10/Box)
- O-RING3/8 O Ring for 3/8" Sack (10/Box)
- O-RING1/2 O Ring for 1/2" Sack (10/Pack)
- 022461 3/8" O Ring
- 022462 1/2" O Ring

1/2" Collection Set and Curette

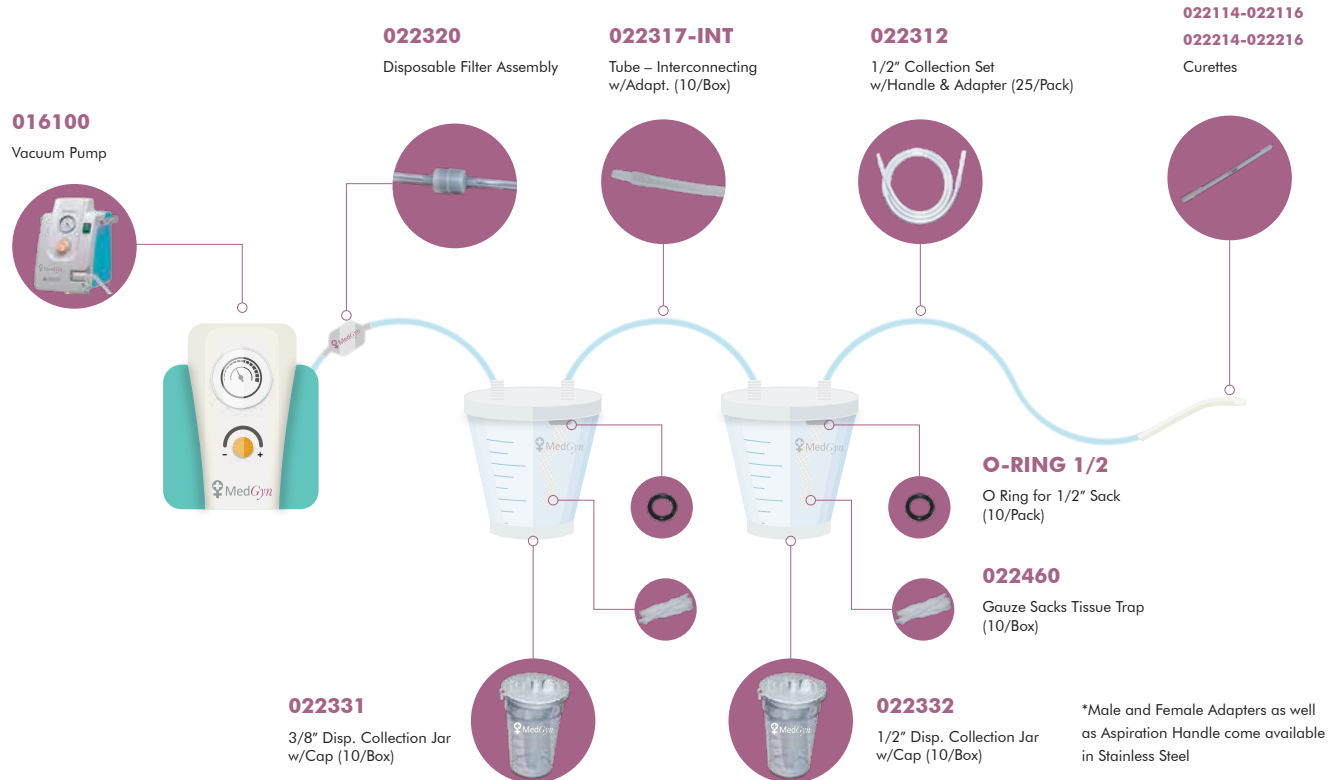

3/8" Collection Set and Curette

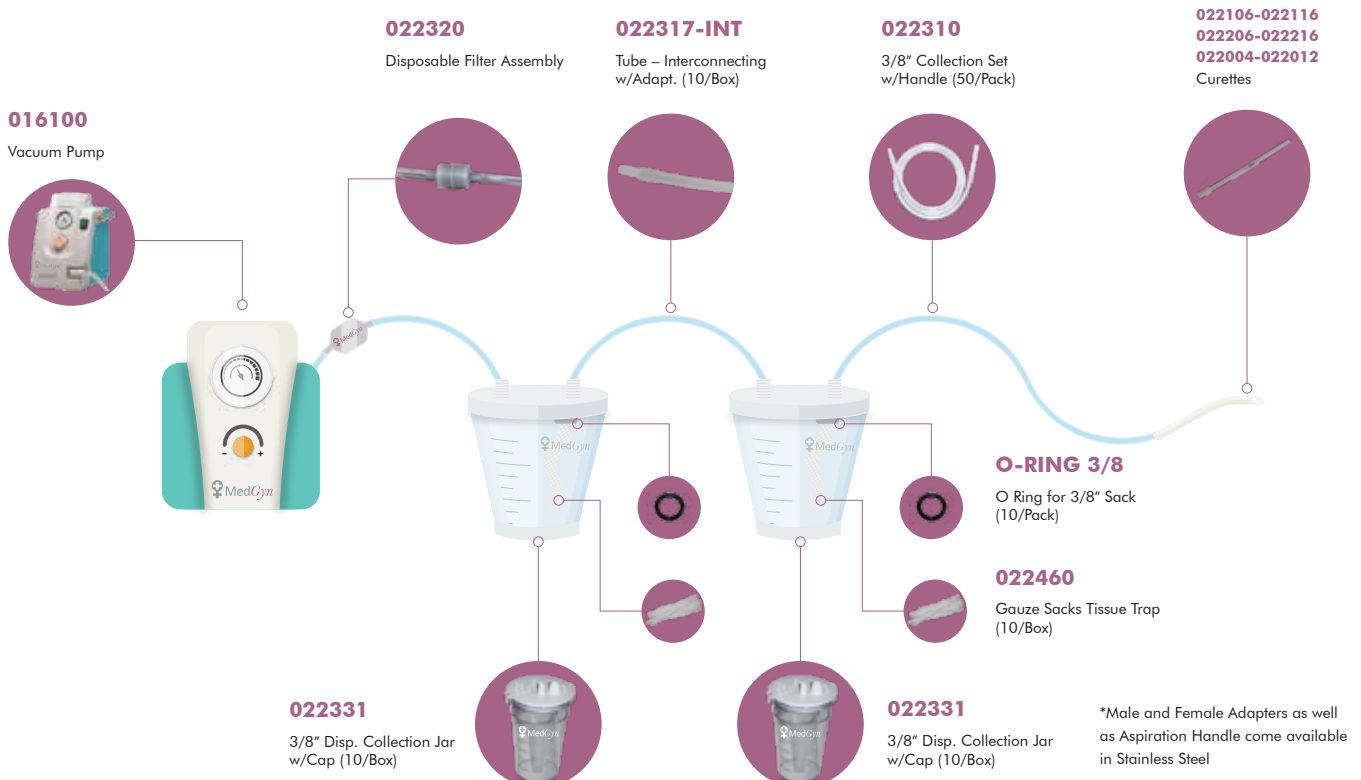

MedGyn Vacuum Cannulas-Curettes

MedGyn offers a complete line of high-quality, disposable vacuum cannulas-curettes in the industry. Available in Rigid Curved, Rigid Straight, Flexible and Flexible Karman options, our cannulas-curettes are individually packaged and sterilized.

Rigid Curved Cannula-Curette

- 022106 6mm (50/Pack)
- 022107 7mm (50/Pack)
- 022108 8mm (50/Pack)
- 022109 9mm (50/Pack)
- 022110 10mm (50/Pack)
- 022111 11mm (50/Pack)
- 022112 12mm (50/Pack)
- 022113 13mm - 3/8" Base (25/Pack)
- 022114 14mm - 1/2" Base (25/Pack)
- 022144 14mm - 1/2" Base w/Adapter (25/Pack)
- 022145 14mm - 3/8" Base (25/Pack)
- 022115 15mm - 1/2" Base (25/Pack)
- 022116 16mm - 1/2" Base (25/Pack)

Rigid Straight Cannula-Curette

- 022206 6mm (50/Pack)
- 022207 7mm (50/Pack)
- 022208 8mm (50/Pack)
- 022209 9mm (50/Pack)
- 022210 10mm (50/Pack)
- 022211 11mm (50/Pack)
- 022212 12mm (50/Pack)
- 022213 13mm - 3/8" Base (25/Pack)
- 022214 14mm - 1/2" Base (25/Pack)
- 022244 14mm - 1/2" Base w/Adapter (25/Pack)
- 022245 14mm - 3/8" Base (25/Pack)
- 022215 15mm - 1/2" Base (25/Pack)
- 022216 16mm - 1/2" Base (25/Pack)

Flexible Cannula-Curette with Dual Port Design

- 022004 4mm (50/Pack)
- 022005 5mm (50/Pack)
- 022006 6mm (50/Pack)
- 022007 7mm (50/Pack)
- 022008 8mm (50/Pack)
- 022009 9mm (50/Pack)
- 022010 10mm (50/Pack)
- 022011 11mm (50/Pack)
- 022012 12mm (50/Pack)

MedGyn Aspiration Kit Double Valve

MedGyn Aspiration Kit Double Valve is used for uterine aspiration/uterine evacuation in obstetrics and gynecologic procedures. The device fits the MedGyn Flexible Karman Curettes and a wide variety of MedGyn Rigid and Straight Curettes.

022526 MedGyn Aspiration Kit Double Valve



Flexible/Karman Cannula-Curette

- 022004K 4mm (10/Pack)
- 022005K 5mm (10/Pack)
- 022006K 6mm (10/Pack)
- 022007K 7mm (10/Pack)
- 022008K 8mm (10/Pack)
- 022009K 9mm (10/Pack)
- 022010K 10mm (10/Pack)
- 022011K 11mm (10/Pack)
- 022012K 12mm (10/Pack)

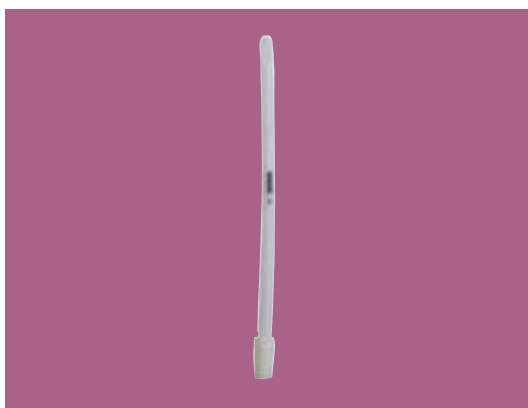

MedGyn Aspiration Kits

MedGyn Aspiration Kit and Aspiration Kit IV are effective devices for simultaneous endometrial curettage and aspiration.

- 022514 MedGyn Aspiration Kit with 4mm Cannula-Curette (10/Pack)
- 022515 MedGyn Aspiration Kit with 5mm Cannula-Curette (10/Pack)
- 022516 MedGyn Aspiration Kit with 6mm Cannula-Curette (10/Pack)
- 022517 MedGyn Aspiration Kit with 7mm Cannula-Curette (10/Pack)
- 022511 MedGyn Aspiration Kit IV with 4mm, 5mm, 6mm and 7mm Cannula-Curette (10/Pack)





MedGyn IUD Kit

This sterile, single use kit contains everything needed to insert or remove an IUD (intrauterine device).

We have included the following products:

022365 MedGyn IUD Kit consists of Cherron Forceps, Pozzy Forceps, Long Littauer Scissors, Uterine Sound (25/Box)



022365-M IUD Kit consisting of Metal Cherron Forceps, Pozzy Forceps, Long Littauer Scissors, Uterine Sound (25/box)

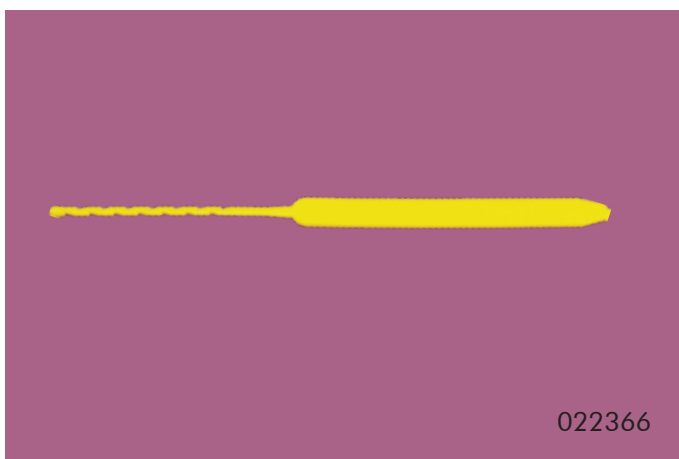

MedGyn's IUD Retriever

MedGyn's IUD Retriever is designed to assist in the removal of the intrauterine device from the uterus.

022366 Disposable IUD Retriever (25/Box)

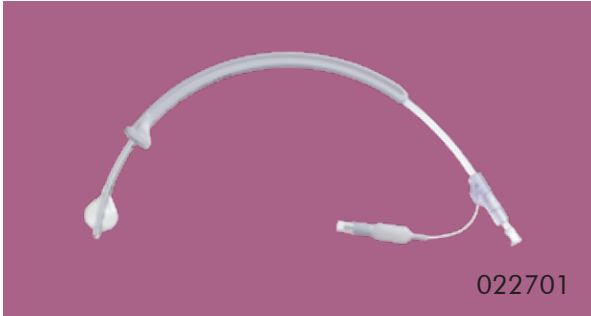

MedGyn Uterine Manipulator

This device is used for laparoscopic tubal occlusion, diagnostic laparoscopy, mini laparotomy, salpingoplasty and fertility exams. Pear-shaped balloon provides optimal hold and a perfect seal at the internal OS. Smaller cannula size allows for easier insertion and comfort.

022701 MedGyn Uterine Manipulator(12/Box)

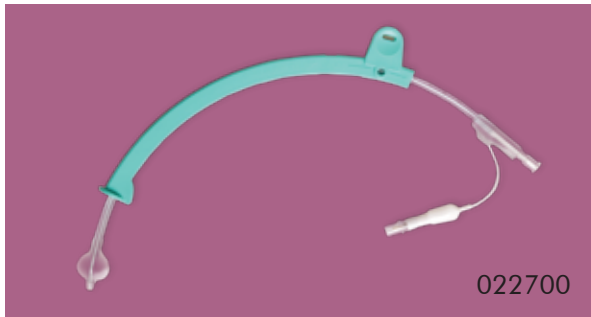

K-UMI Uterine Manipulator/Injector

This device is used for laparoscopic tubal occlusion, diagnostic laparoscopy, mini laparotomy, salpingoplasty and fertility exams. Pear-shaped balloon provides optimal hold and a perfect seal at the internal OS. Smaller cannula size allows for easier insertion and comfort.

022700 MedGyn K-UMI Uterine Manipulator



MedGyn Uterine Sounds

MedGyn Disposable Uterine Sounds are made of malleable plastic with centimeter graduations for accurate measurement of uterine cavity.

020250 MedGyn Disposable Uterine Sounds
O.D. 3mm 10" Length with Marking
(25/Box)

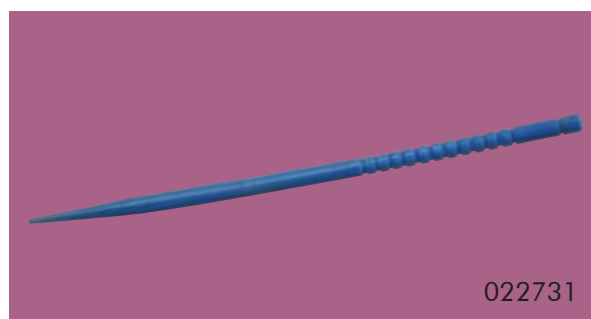

MedGyn Os Finders

Ideal for cervical dilation, uterine sounding or other intrauterine procedures. Made of semi-flexible plastic and packaged individually sterile.

022731 MedGyn Disposable Os Finder (50/Pack)

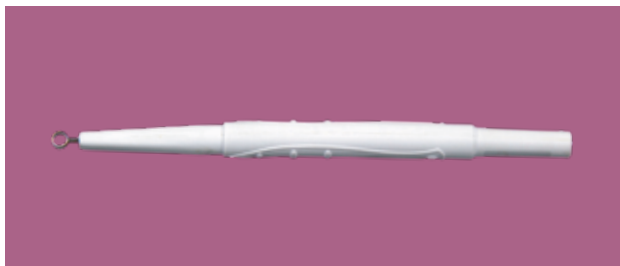

MedGyn's Disposable Derma Curette

- 022797-2 Disposable Derma Curette 2.0mm
- 022797-3 Disposable Derma Curette 3.0mm
- 022797-4 Disposable Derma Curette 4.0mm
- 022797-5 Disposable Derma Curette 5.0mm
- 022797-7 Disposable Derma Curette 7.0mm



MedGyn's Disposable Derma (Keyes Biopsy) Punch

MedGyn's latest products include a disposable derma (keyes biopsy) punch made of quality stainless steel and a ribbed sturdy handle for the ejection of lodged specimen.

- 022727-1 Disposable Derma (Keyes Biopsy) Punch 1mm
- 022727-2 Disposable Derma (Keyes Biopsy) Punch 2mm
- 022727-3 Disposable Derma (Keyes Biopsy) Punch 3mm
- 022727-4 Disposable Derma (Keyes Biopsy) Punch 4mm
- 022727-5 Disposable Derma (Keyes Biopsy) Punch 5mm



MedGyn's Disposable Scalpel

MedGyn's latest products include disposable scalpels made of quality stainless steel blades with sturdy, non-slip plastic handles.

- 022798-11 Disposable Scalpel #11
- 022798-15 Disposable Scalpel #15



MedGyn Word Bartholin's Catheter

For use following an incision and drainage of a Bartholin's cyst or abscess. Catheter kit includes balloon catheter, syringe for balloon inflation and scalpel.

- 022719 MedGyn Word Bartholin's Catheter (6/Box)

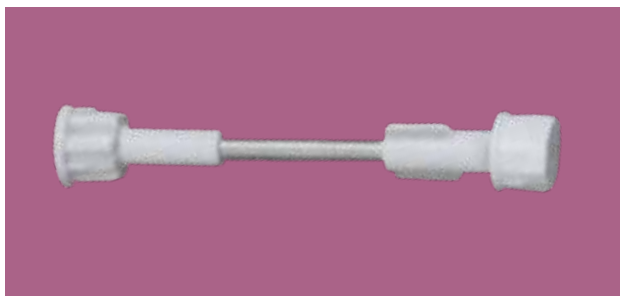

MedGyn Needle Extender

An effective means of extending ordinary hypodermic needles when longer needles are required.

- 022600 MedGyn Disposable Needle Extender

MedGyn Silicone Pessaries

Pessaries are an effective tool for the non-surgical treatment of a variety of gynecologic problems. Commonly used for management of pelvic support defects, pessaries are also used to treat stress urinary incontinence. MedGyn offers an extensive line of quality medical-grade silicone pessaries and easy-to-use pessary fitting sets. MedGyn Pessaries are latex free.



051001 MedGyn Pessary Case
(28 different pessaries including
Ring Fitting Set)



051000 Ring w/o Support
Pessary Fitting Set of 6



051005 Ring w/ Support
Pessary Fitting Set of 6



051006 Shaatz
Pessary Fitting Set of 6



MedGyn Ring with Support

- 050026** Ring w/ Support #1 (51mm, 2in)
- 050027** Ring w/ Support #2 (57mm, 2.2in)
- 050028** Ring w/ Support #3 (62mm, 2.4in)
- 050029** Ring w/ Support #4 (70mm, 2.75in)
- 050030** Ring w/ Support #5 (74mm, 2.9in)
- 050031** Ring w/ Support #6 (82mm, 3.2in)
- 050032** Ring w/ Support #7 (89mm, 3.5in)
- 050033** Ring w/ Support #8 (96mm, 3.8in)
- 050034** Ring w/ Support #9 (102mm, 4in)

MedGyn Ring w/o Support

- 050017** Ring w/o Support #1 (51mm, 2in)
- 050018** Ring w/o Support #2 (57mm, 2.2in)
- 050019** Ring w/o Support #3 (62mm, 2.4in)
- 050020** Ring w/o Support #4 (70mm, 2.75in)
- 050021** Ring w/o Support #5 (74mm, 2.9in)
- 050022** Ring w/o Support #6 (82mm, 3.2in)
- 050023** Ring w/o Support #7 (89mm, 3.5in)
- 050024** Ring w/o Support #8 (96mm, 3.8in)
- 050025** Ring w/o Support #9 (102mm, 4in)



MedGyn Modified Cup with Drain

- 050210M** Modified Cup #1 w/ Drain (65mm, 2.6in)
- 050211M** Modified Cup #2 w/ Drain (70mm, 2.8in)
- 050212M** Modified Cup #3 w/ Drain (65mm, 2.6in)
- 050213M** Modified Cup #4 w/ Drain (70mm, 2.8in)
- 050214M** Modified Cup #5 w/ Drain (65mm, 2.6in)
- 050215M** Modified Cup #6 w/ Drain (70mm, 2.8in)

MedGyn Modified Cup w/o Drain

- 050191M** Modified Cup #1 w/o Drain (65mm, 2.6in)
- 050192M** Modified Cup #2 w/o Drain (70mm, 2.8in)
- 050193M** Modified Cup #3 w/o Drain (65mm, 2.6in)
- 050194M** Modified Cup #4 w/o Drain (70mm, 2.8in)
- 050195M** Modified Cup #5 w/o Drain (65mm, 2.6in)
- 050196M** Modified Cup #6 w/o Drain (70mm, 2.8in)



MedGyn Ring with Knob with Support

- 050026K Ring w/ Knob - w/ Support #1 (51mm, 2in)
- 050027K Ring w/ Knob - w/ Support #2 (57mm, 2.2in)
- 050028K Ring w/ Knob - w/ Support #3 (63mm, 2.5in)
- 050029K Ring w/ Knob - w/ Support #4 (70mm, 2.8in)
- 050030K Ring w/ Knob - w/ Support #5 (76mm, 3in)
- 050031K Ring w/ Knob - w/ Support #6 (83mm, 3.3in)
- 050032K Ring w/ Knob - w/ Support #7 (89mm, 3.5in)

MedGyn Ring w/ Knob w/o Support

- 050017K Ring w/ Knob - w/o Support #1 (51mm, 2in)
- 050018K Ring w/ Knob - w/o Support #2 (57mm, 2.2in)
- 050019K Ring w/ Knob - w/o Support #3 (63mm, 2.5in)
- 050020K Ring w/ Knob - w/o Support #4 (70mm, 2.8in)
- 050021K Ring w/ Knob - w/o Support #5 (76mm, 3in)
- 050022K Ring w/ Knob - w/o Support #6 (83mm, 3.3in)
- 050023K Ring w/ Knob - w/o Support #7 (89mm, 3.5in)



MedGyn Marland with Support

- 050084 Marland w/ Support #2 (57mm, 2.25in)
- 050085 Marland w/ Support #3 (63mm, 2.5in)
- 050086 Marland w/ Support #4 (70mm, 2.75in)
- 050087 Marland w/ Support #5 (76mm, 3in)
- 050088 Marland w/ Support #6 (83mm, 3.25in)
- 050089 Marland w/ Support #7 (89mm, 3.5in)
- 050090 Marland w/ Support #8 (95mm, 3.75in)

MedGyn Marland w/o Support

- 050077 Marland w/o Support #2 (57mm, 2.25in)
- 050078 Marland w/o Support #3 (63mm, 2.5in)
- 050079 Marland w/o Support #4 (70mm, 2.75in)
- 050080 Marland w/o Support #5 (76mm, 3in)
- 050081 Marland w/o Support #6 (83mm, 3.25in)
- 050082 Marland w/o Support #7 (89mm, 3.5in)
- 050083 Marland w/o Support #8 (95mm, 3.75in)



MedGyn Gellhorn with Drain

- 050155 Gellhorn w/ Drain #1 (44mm, 1.7in)
- 050156 Gellhorn w/ Drain #2 (51mm, 2in)
- 050157 Gellhorn w/ Drain #3 (57mm, 2.2in)
- 050158 Gellhorn w/ Drain #4 (63mm, 2.5in)
- 050159 Gellhorn w/ Drain #5 (70mm, 2.8in)
- 050160 Gellhorn w/ Drain #6 (76mm, 3in)
- 050161 Gellhorn w/ Drain #7 (82mm, 3.2in)
- 050162 Gellhorn w/ Drain #8 (89mm, 3.5in)



MedGyn Gellhorn Short Stem

Stem Height 28 mm, 1.1 in

- 050155S Gellhorn Short Stem #1 (44mm, 1.7in)
- 050156S Gellhorn Short Stem #2 (51mm, 2in)
- 050157S Gellhorn Short Stem #3 (57mm, 2.2in)
- 050158S Gellhorn Short Stem #4 (63mm, 2.5in)
- 050159S Gellhorn Short Stem #5 (70mm, 2.8in)
- 050160S Gellhorn Short Stem #6 (76mm, 3in)
- 050161S Gellhorn Short Stem #7 (82mm, 3.2in)
- 050162S Gellhorn Short Stem #8 (89mm, 3.5in)

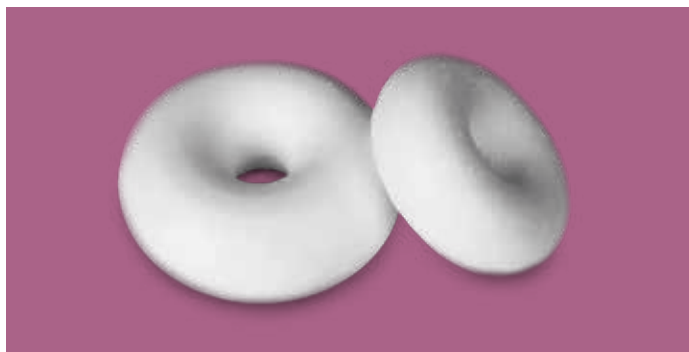

MedGyn Donut

- 050010 Donut #0 (51mm, 2in)
- 050011 Donut #1 (57mm, 2.2in)
- 050012 Donut #2 (64mm, 2.5in)
- 050013 Donut #3 (69mm, 2.7in)
- 050014 Donut #4 (76mm, 3in)
- 050015 Donut #5 (82mm, 3.2in)
- 050016 Donut #6 (88mm, 3.5in)
- 050199 Donut #7 (95mm, 3.7in)



MedGyn Shaatz with Drain

- 050120 Shaatz w/ Drain #0 (38mm, 1.5in)
- 050121 Shaatz w/ Drain #1 (44mm, 1.75in)
- 050122 Shaatz w/ Drain #2 (51mm, 2in)
- 050123 Shaatz w/ Drain #3 (57mm, 2.2in)
- 050124 Shaatz w/ Drain #4 (64mm, 2.5in)
- 050125 Shaatz w/ Drain #5 (70mm, 2.8in)
- 050126 Shaatz w/ Drain #6 (76mm, 3in)
- 050127 Shaatz w/ Drain #7 (82mm, 3.2in)
- 050128 Shaatz w/ Drain #8 (88mm, 3.5in)



MedGyn Cup with Support

- 050171 Cup w/ Support #0 (48mm, 1.8in)
- 050172 Cup w/ Support #1 (52mm, 2in)
- 050173 Cup w/ Support #2 (57mm, 2.25in)
- 050174 Cup w/ Support #3 (63mm, 2.5in)
- 050175 Cup w/ Support #4 (68mm, 2.7in)
- 050176 Cup w/ Support #5 (73mm, 2.9in)
- 050177 Cup w/ Support #6 (77mm, 3in)
- 050178 Cup w/ Support #7 (82mm, 3.2in)

MedGyn Cup w/o Support

- 050163 Cup w/o Support #0 (48mm, 1.8in)
- 050164 Cup w/o Support #1 (52mm, 2in)
- 050165 Cup w/o Support #2 (57mm, 2.25in)
- 050166 Cup w/o Support #3 (63mm, 2.5in)
- 050167 Cup w/o Support #4 (68mm, 2.7in)
- 050168 Cup w/o Support #5 (73mm, 2.9in)
- 050169 Cup w/o Support #6 (77mm, 3in)
- 050170 Cup w/o Support #7 (82mm, 3.2in)



MedGyn Gehrung with Support

- 050145 Gehrung w/ Support #0 (50mm, 1.9in)
- 050146 Gehrung w/ Support #1 (55mm, 2.2in)
- 050147 Gehrung w/ Support #2 (60mm, 2.4in)
- 050148 Gehrung w/ Support #3 (65mm, 2.6in)
- 050149 Gehrung w/ Support #4 (70mm, 2.8in)
- 050150 Gehrung w/ Support #5 (75mm, 3in)
- 050151 Gehrung w/ Support #6 (80mm, 3.2in)
- 050152 Gehrung w/ Support #7 (85mm, 3.4in)
- 050153 Gehrung w/ Support #8 (90mm, 3.6in)



MedGyn Cube with Drain

- 050066 Cube w/ Drain #0 (25mm, 0.98in)
- 050067 Cube w/ Drain #1 (29mm, 1.1in)
- 050068 Cube w/ Drain #2 (32mm, 1.2in)
- 050069 Cube w/ Drain #3 (36mm, 1.4in)
- 050070 Cube w/ Drain #4 (40mm, 1.6in)
- 050071 Cube w/ Drain #5 (45mm, 1.8in)
- 050072 Cube w/ Drain #6 (49mm, 1.9in)
- 050073 Cube w/ Drain #7 (55mm, 2.2in)
- 050074 Cube w/ Drain #8 (63mm, 2.5in)
- 050075 Cube w/ Drain #9 (69mm, 2.7in)
- 050076 Cube w/ Drain #10 (74mm, 2.9in)

MedGyn Cube w/o Drain

- 050055 Cube w/o Drain #0 (25mm, 0.98in)
- 050056 Cube w/o Drain #1 (29mm, 1.1in)
- 050057 Cube w/o Drain #2 (32mm, 1.2in)
- 050058 Cube w/o Drain #3 (36mm, 1.4in)
- 050059 Cube w/o Drain #4 (40mm, 1.6in)
- 050060 Cube w/o Drain #5 (45mm, 1.8in)
- 050061 Cube w/o Drain #6 (49mm, 1.9in)
- 050062 Cube w/o Drain #7 (55mm, 2.2in)
- 050063 Cube w/o Drain #8 (63mm, 2.5in)
- 050064 Cube w/o Drain #9 (69mm, 2.7in)
- 050065 Cube w/o Drain #10 (74mm, 2.9in)

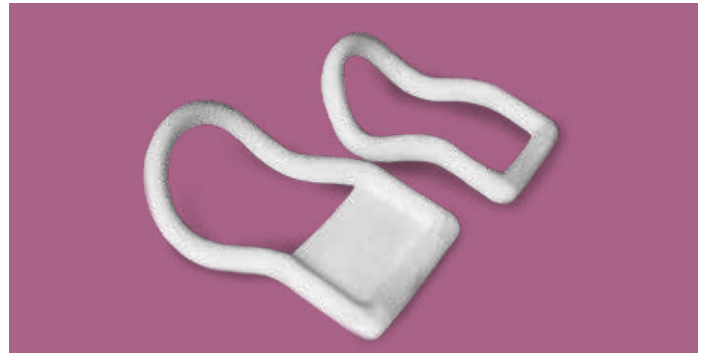

MedGyn Hodge with Support

- 050045 Hodge w/ Support #0 (65mm, 2.6in)
- 050046 Hodge w/ Support #1 (70mm, 2.8in)
- 050047 Hodge w/ Support #2 (75mm, 3in)
- 050048 Hodge w/ Support #3 (80mm, 3.2in)
- 050049 Hodge w/ Support #4 (85mm, 3.4in)
- 050050 Hodge w/ Support #5 (90mm, 3.6in)
- 050051 Hodge w/ Support #6 (95mm, 3.8in)
- 050052 Hodge w/ Support #7 (100mm, 4in)
- 050053 Hodge w/ Support #8 (105mm, 4.2in)
- 050054 Hodge w/ Support #9 (110mm, 4.4in)

MedGyn Hodge w/o Support

- 050035 Hodge w/o Support #0 (65mm, 2.6in)
- 050036 Hodge w/o Support #1 (70mm, 2.8in)
- 050037 Hodge w/o Support #2 (75mm, 3in)
- 050038 Hodge w/o Support #3 (80mm, 3.2in)
- 050039 Hodge w/o Support #4 (85mm, 3.4in)
- 050040 Hodge w/o Support #5 (90mm, 3.6in)
- 050041 Hodge w/o Support #6 (95mm, 3.8in)
- 050042 Hodge w/o Support #7 (100mm, 4in)
- 050043 Hodge w/o Support #8 (105mm, 4.2in)
- 050044 Hodge w/o Support #9 (110mm, 4.4in)

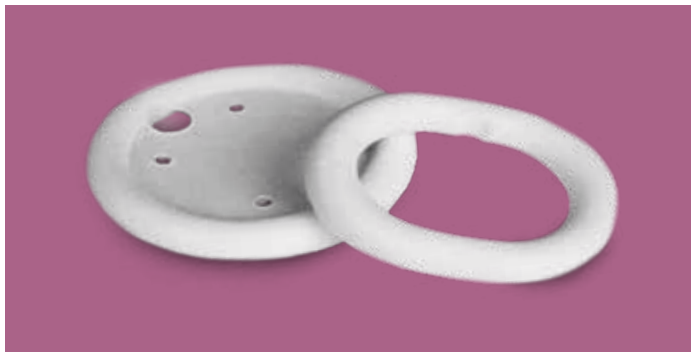

MedGyn Oval with Support

- 050111 Oval w/ Support #1 (51mm, 2in)
- 050112 Oval w/ Support #2 (57mm, 2.25in)
- 050113 Oval w/ Support #3 (64mm, 2.5in)
- 050114 Oval w/ Support #4 (69mm, 2.7in)
- 050115 Oval w/ Support #5 (76mm, 3in)
- 050116 Oval w/ Support #6 (83mm, 3.25in)
- 050117 Oval w/ Support #7 (89mm, 3.5 in)
- 050118 Oval w/ Support #8 (95mm, 3.75in)
- 050119 Oval w/ Support #9 (102mm, 4in)

MedGyn Oval w/o Support

- 050101 Oval w/o Support #1 (51mm, 2in)
- 050102 Oval w/o Support #2 (57mm, 2.25in)
- 050103 Oval w/o Support #3 (64mm, 2.5in)
- 050104 Oval w/o Support #4 (69mm, 2.7in)
- 050105 Oval w/o Support #5 (76mm, 3in)
- 050106 Oval w/o Support #6 (83mm, 3.25in)
- 050107 Oval w/o Support #7 (89mm, 3.5in)
- 050108 Oval w/o Support #8 (95mm, 3.75 in)
- 050109 Oval w/o Support #9 (102mm, 4in)



MedGyn Dish with Support

- 050137 Dish w/ Support #0 (50mm, 2in)
- 050138 Dish w/ Support #1 (55mm, 2.2in)
- 050139 Dish w/ Support #2 (60mm, 2.4in)
- 050140 Dish w/ Support #3 (63mm, 2.5in)
- 050141 Dish w/ Support #4 (68mm, 2.7in)
- 050142 Dish w/ Support #5 (73mm, 2.9in)
- 050143 Dish w/ Support #6 (80mm, 3.1in)
- 050144 Dish w/ Support #7 (85mm, 3.3in)

MedGyn Dish w/o Support

- 050129 Dish w/o Support #0 (50mm, 2in)
- 050130 Dish w/o Support #1 (55mm, 2.2in)
- 050131 Dish w/o Support #2 (60mm, 2.4in)
- 050132 Dish w/o Support #3 (63mm, 2.5in)
- 050133 Dish w/o Support #4 (68mm, 2.7in)
- 050134 Dish w/o Support #5 (73mm, 2.9in)
- 050135 Dish w/o Support #6 (80mm, 3.1in)
- 050136 Dish w/o Support #7 (85mm, 3.3in)



031315

MedGyn Pessary Remover

Designed to aid in the removal of many pessaries, the firm grip and flexibility allows patients to safely and easily remove their own pessaries. The high-quality plastic is not cold, unlike metal removers, greatly increasing patient comfort.

031315 Pessary Remover

Graves Speculum

Wider blade design

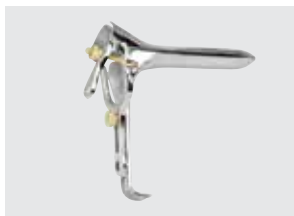

- 030905 XSmall 3/4" x 2 3/4" (19mm x 70mm)
- 030901 Small 3/4" x 3" (19mm x 76mm)
- 030902 Medium 1 3/8" x 4" (35mm x 102mm)
- 030903 Large 1 3/8" x 4 3/4" (35mm x 121mm)
- 030904 XLarge 1 1/2" x 6 1/2" (38mm x 165mm)
- 030900 Extra Long Snowman Clinton 1 1/2" x 6" (38mm x 152mm)

Graves Vu-More Speculum

Wider blade design with larger view area (4cm vs. standard 3cm).

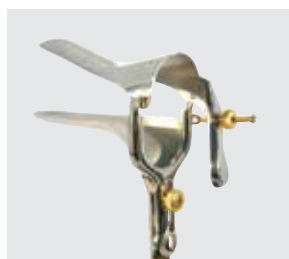

- 030952 Small 3 3/4" (95mm)
- 030953 Medium 4 1/2" (114mm)
- 030954 Large 5" (127mm)
- 030955 XLong 6" (152mm)
- 030956 XLong 6 1/8" (161mm)
- 030957 XLong 6 3/4" (171mm)
- 030958 XLong 7" (178mm)

Graves Speculum

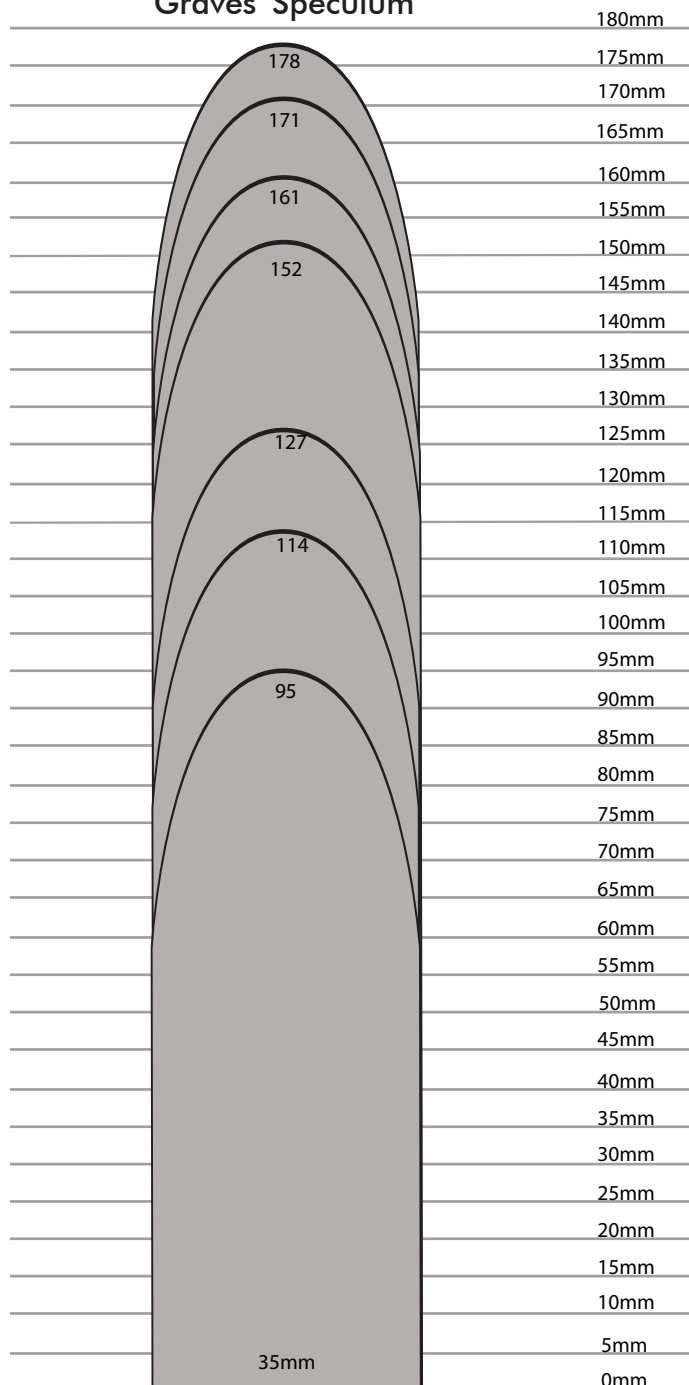

Graves Vu-More Speculum

Wider blade design with larger view area (4cm vs. standard 3cm) with durable coating.

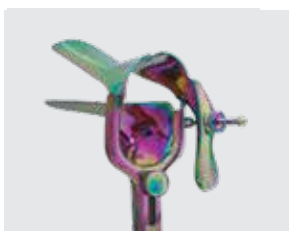

- 030985 Medium 4 1/2" (114mm)
- 030986 Large 5" (127mm)

Graves Vu-Max Speculum

Wider blade design with largest view area (7cm vs. standard 3cm) with durable coating.



- 030987 Medium 4 1/2" (114mm)
- 030988 Large 5" (127mm)

Graves Vu-Max Speculum

Wider blade design with largest view area (7cm vs. standard 3cm).

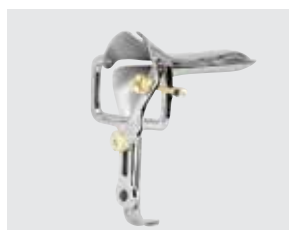

- 030975 Medium 4 1/2" (114mm)
- 030976 Large 5" (127mm)
- 030977 XLong 6" (152mm)
- 030978 XLong 6 1/8" (161mm)
- 030979 XLong 6 3/4" (171mm)
- 030980 XLong 7" (178mm)

Moore Graves Speculum

Short blade design

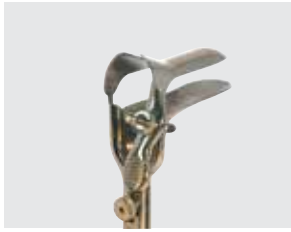

030920 1 1/4" x 3 1/2" (32mm x 89mm)

Weisman Graves Speculum

Open-side speculum



- 030911-SM Small - Right 3/8" x 3" (10mm x 76mm)
- 030911 Medium - Right 1 3/8" x 4" (35mm x 102mm)
- 030911-LG Large - Right 1 3/8" x 4 3/4" (35mm x 121mm)
- 030911-XL XLarge - Right 1 1/2" x 6 1/2" (38mm x 165mm)
- 030912 Medium - Left 1 3/8" x 4" (35mm x 102mm)
- 030912-LG Large - Left 1 3/8" x 4 3/4" (35mm x 121mm)
- 030912-XL XLarge - Left 1 1/2" x 6 1/2" (38mm x 165mm)

Graves Speculum

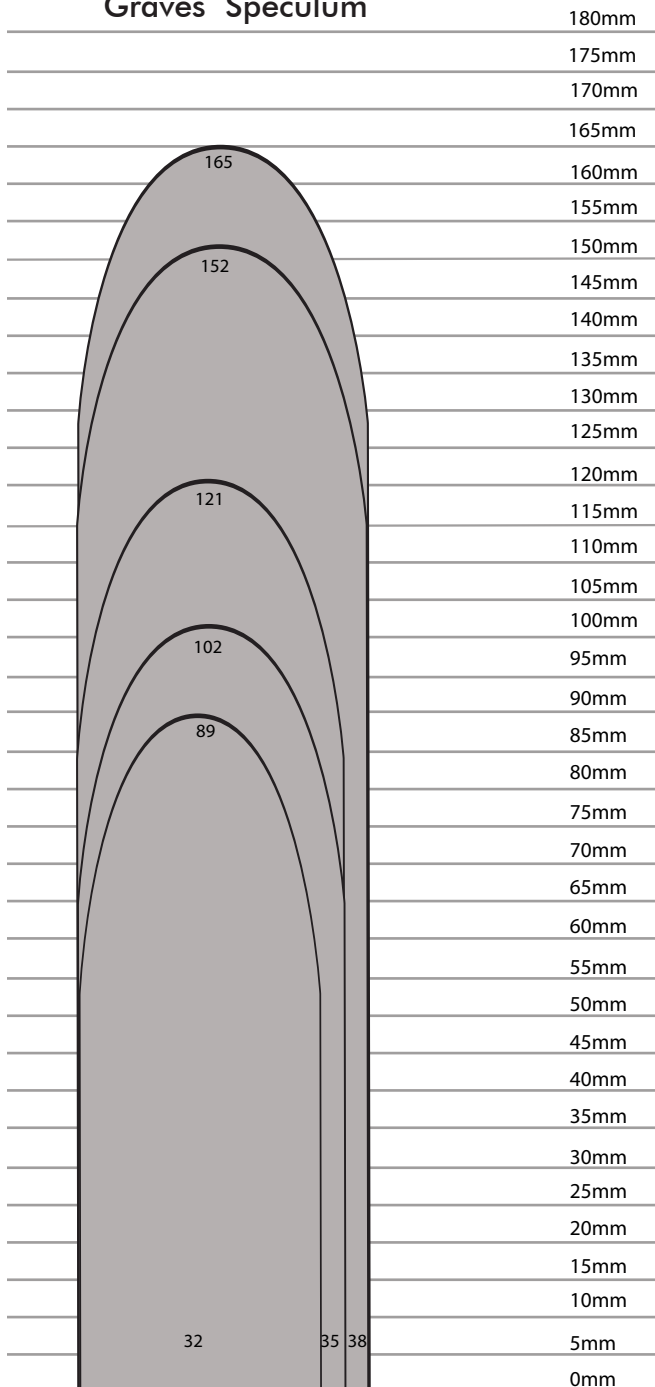

Graves Wide Angled Speculum

Wider Graves blade design with 45° open angle.



- 030909 Medium 1 3/8" x 4" (35mm x 102mm)
- 030910 Right Side Open Medium 1 3/8" x 4" (35mm x 102mm)
- 030971 Right Side Open Large 1 3/8" x 4 3/4" (35mm x 121mm)

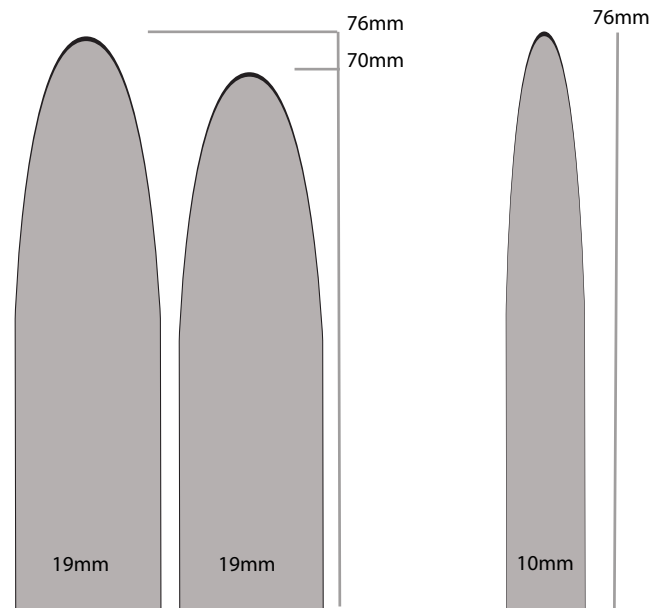

Pederson Speculum

Narrow blade design



- 030941 XNarrow 5/8" x 4" (17mm x 102mm)
- 030913 XSmall 1/2" x 2 3/4" (13mm x 70mm)
- 030906 Small 1/2" x 3" (13mm x 76mm)
- 030907 Medium 7/8" x 4" (22mm x 102mm)
- 030908 Large 1" x 4 3/4" (25mm x 121mm)
- 030914 XLarge 1" x 6 1/2" (25mm x 165mm)
- 030917 Extra Long Snowman Clinton 1" x 6" (25mm x 152mm)

Pederson Speculum

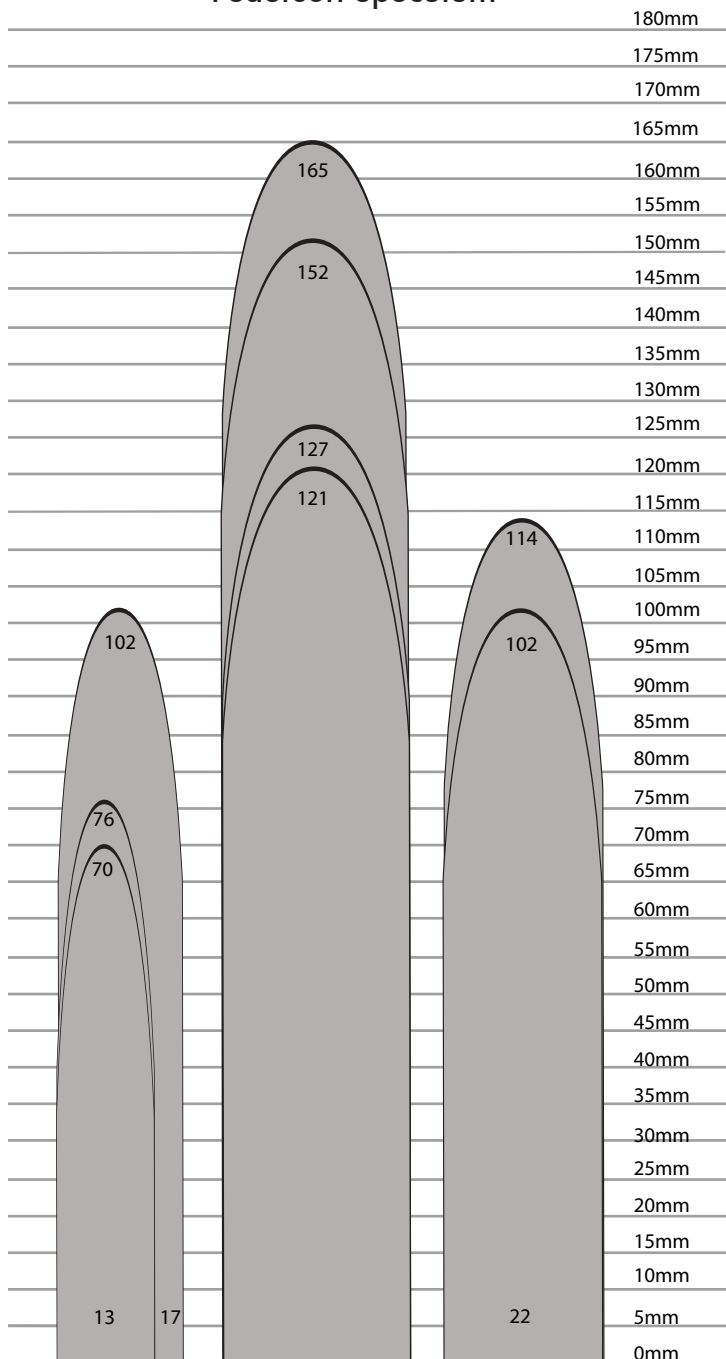

Pederson Vu-More Speculum

Larger view area (4cm vs. standard 3cm) with durable coating.



- 030981 Medium 4 1/2" (114mm)
- 030982 Large 5" (127mm)

Pederson Vu-Max Speculum

Largest view area (7cm vs. standard 3cm) with durable coating.



- 030983 Medium 4 1/2" (114mm)
- 030984 Large 5" (127mm)

Pederson - Open Side Speculum

Narrow blade design with open side



- 030972 45° Medium - Right 7/8" x 4" (22mm x 102mm)
- 030973 45° Large - Right 1" x 4 3/4" (25mm x 121mm)
- 030942 XNarrow - Right 5/8" x 4" (17mm x 102mm)
- 030943 XNarrow - Left 5/8" x 4" (17mm x 102mm)
- 030939 Medium - Right 7/8" x 4" (22mm x 102mm)
- 030939-LT Medium - Left 7/8" x 4" (22mm x 102mm)
- 030908R Large - Right 1" x 4 3/4" (25mm x 121mm)
- 030908-LT Large - Left 1" x 4 3/4" (25mm x 121mm)
- 030914-L-XL XLarge - Left 1" x 6 1/2" (25mm x 165mm)
- 030914-R-XL XLarge - Right 1" x 6 1/2" (25mm x 165mm)

Klopfers Speculum

Wider opening (4cm) and short blade

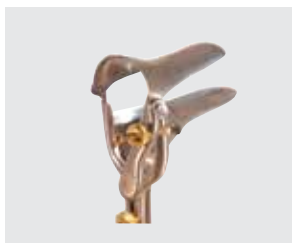

030931 1 3/8" x 3 1/2" (35mm x 89mm)

Grundman Speculum

Wide open design with screw adjustment/lever



- 030949 Small 1 1/3" x 3 1/3" (34mm x 85mm)
- 030950 Medium 1 3/8" x 3 3/4" (35mm x 95mm)
- 030951 Large 1 1/2" x 4 3/4" (38mm x 121mm)

Cusco Speculum

Unique handle-design speculum with center screw or side screw options.



- 030960 Small w/Center Screw 1 1/3" x 3 1/2" (34mm x 89mm)
- 030961 Medium w/Center Screw 1 3/8" x 4" (35mm x 102mm)
- 030962 Large w/Center Screw 1 3/8" x 4 1/2" (35mm x 114mm)
- 030963 Small w/Side Screw 1 1/3" x 3 1/2" (34mm x 89mm)
- 030964 Medium w/Side Screw 1 3/8" x 4" (35mm x 102mm)
- 030965 Large w/Side Screw 1 3/8" x 4 1/2" (35mm x 114mm)

Klopfers, Grundman, Cusco, For-Way Speculum

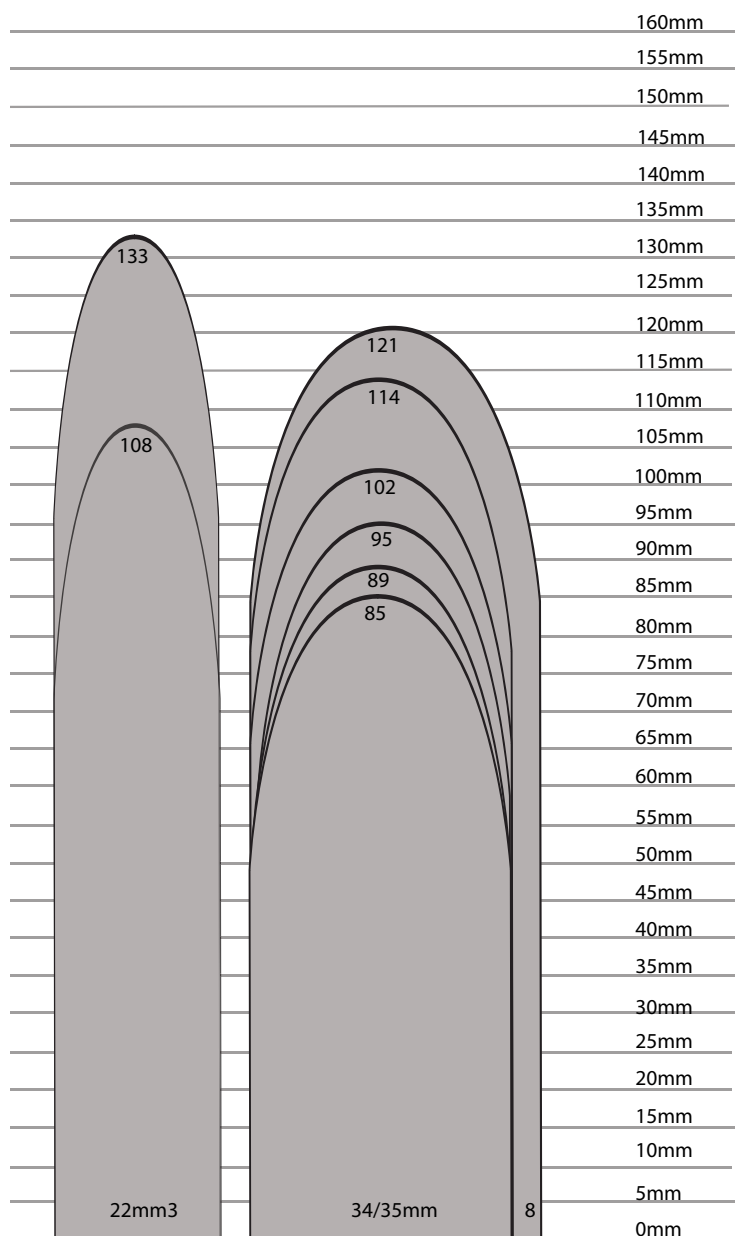

Four-Way Speculum

The design of this speculum combines the characteristics of both a standard speculum and a vaginal wall retractor.



- 038095 4-Way Lateral Expander Speculum - Medium 7/8" x 4 1/4" (22mm x 108mm)
- 038096 4-Way Lateral Expander Speculum - Large 7/8" x 5 1/4" (22mm x 133mm)

Weighted Speculum



- 030921 Auvard 2.0lbs, 75° angle, Blade 1½" x 3¼" (38mm x 83mm)
- 030922 Auvard 2.5lbs, 75° angle, Blade 1½" x 3¼" (38mm x 83mm)
- 030923 Auvard 3.0lbs, 75° angle, Blade 1½" x 3¼" (38mm x 83mm)
- 030924 Auvard 2.5lbs, 45° angle, Blade 1⅔" x 4" (35mm x 102mm)
- 030926 Auvard 2.5lbs, 90° angle, Blade 1" x 5½" (25mm x 140mm)

Collins Speculum

The unique hands-free design offers the advantages of an open-sided speculum while permitting multiple positioning for optimal exposure with blades that open laterally instead of vertically.



- 030946 1¼" x 3¾" (32mm x 95mm)
- 030947 1⅔" x 4" (35mm x 102mm)
- 030948 1⅝" x 4½" (41mm x 114mm)

Lateral Vaginal Wall Retractor

Used for the retraction of vaginal wall and made to fit inside any standard speculum to expand past blades of speculum. Allows for greater exposure of cervix for safer, more accurate procedures.

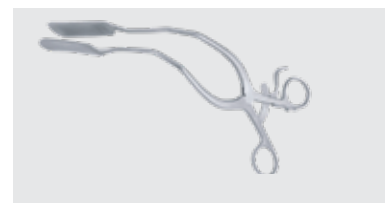

- 030970 Lateral Vaginal Wall Retractor Blue Titanium
- 030966 Open ½" (13mm), 10" (254mm), Blade Size 1" x 2½" (25mm x 64mm)
- 030967 Open 1" (25mm), 10" (254mm), Blade Size 1" x 2½" (25mm x 64mm)
- 030968 Wide Open, 10" (254mm), Blade Size 1" x 2½" (25mm x 64mm)
- 030969 Closed, 10" (254mm), Blade Size 1" x 2½" (25mm x 64mm)

Collins Speculum

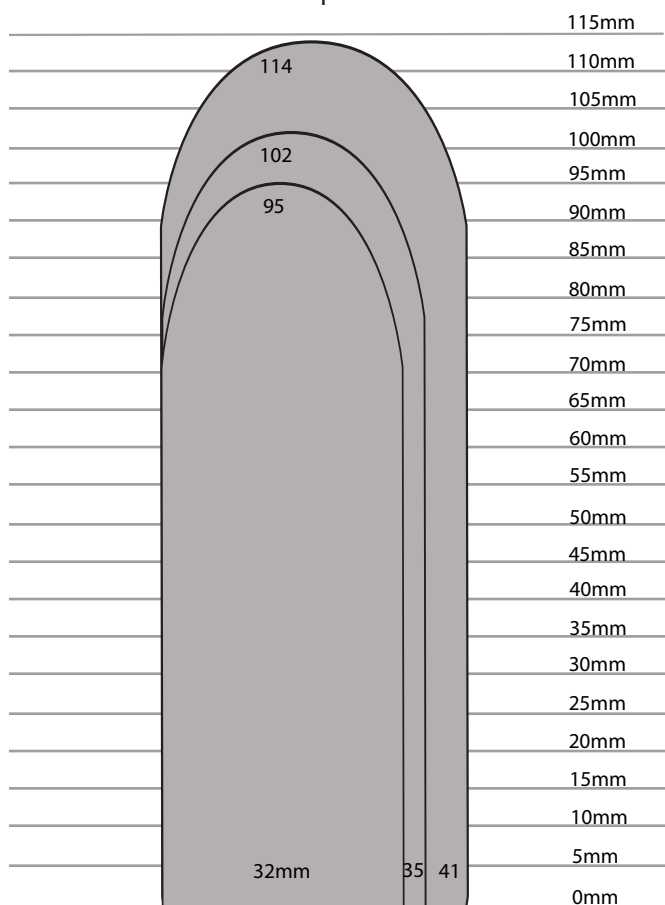

Endocervical Speculum

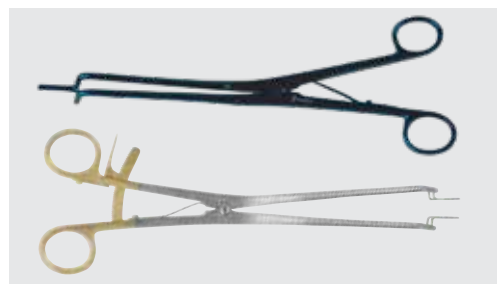
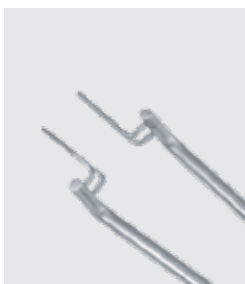

- 030205 Endocervical Speculum Blue Titanium
- 030915 Kogan with Screw 2-4mm
- 030916 Kogan with Screw 4-8mm
- 030201 Kogan with Gauge & Ratchet 2-4mm
- 030202 Kogan with Gauge & Ratchet 4-8mm
- 030203 Kogan with Gauge & Ratchet 8-12mm
- 030204 Townsend Endocervical Speculum 8-12mm

MedGyn Tenaculums

Schroeder Braun Single-Tooth Tenaculum

- 031004 Schroeder Braun Single-Tooth - 9¾" (248mm)
- 031019 Schroeder Braun Tenaculum Light-Touch Straight - 9¾" (248mm)
- 031034 Schroeder Braun Tenaculum Economy - 9¾" (248 mm)
- 031018 Braun Tenaculum Light-Touch Round - 7¼" (184mm)

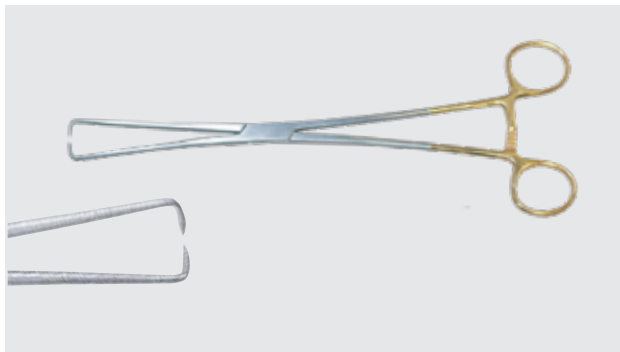

Skene Single-Tooth Tenaculum

- 031006 Skene Single-Tooth-Side-Curve - 10" (254mm)



Duplay Single-Tooth Tenaculum

- 031008 Duplay Single-Tooth Double-Curve - 11" (279mm)



Barrett Tenaculum

- 031009 Barrett Straight - 7¼" (184mm)

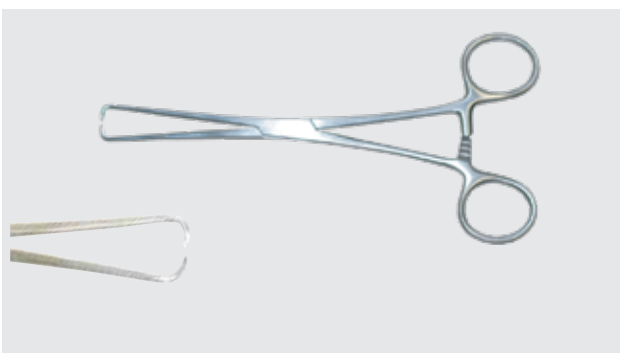

Jacobson Double-Tooth Tenaculum

- 031199 Jacobson Double-Tooth 10" Straight - 2x2 Teeth with Larger Rings (254mm)
- 031200 Jacobson Double-Tooth 10" Side Curve - 2x2 Teeth with Larger Rings (254mm)





Schroeder Double-Tooth Tenaculum

- 031011 Schroeder Double-Tooth - 10" Straight (254mm)
- 031012 Schroeder Double-Tooth - 10" Curved (254mm)
- 031013 Schroeder Double-Tooth - 10" Side Curve (254mm)

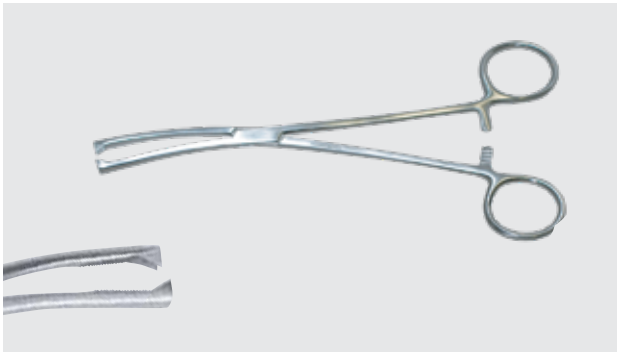

Jacobs Double-Tooth Tenaculum

- 031197 Jacobs Double-Tooth 8½" Straight - 2x2 Teeth (215mm)
- 031198 Jacobs Double-Tooth 8½" Side Curve - 2x2 Teeth (215mm)

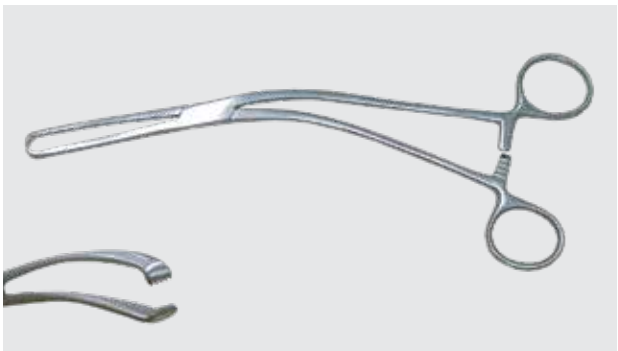

Bierer Tenaculum

- 031010 Bierer Angled 5x6 Teeth, 9" (229mm)
- 031033 Bierer Angled 5x6 Teeth, Economy 9" (229mm)

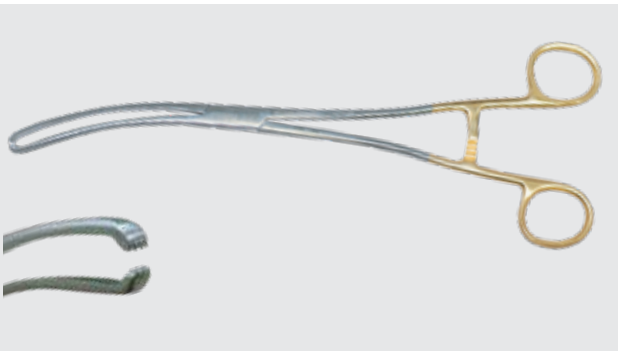

Teale Tenaculum

- 031005 Teale Curved, 3x4 Teeth, 5mm Wide, 10" (254mm)

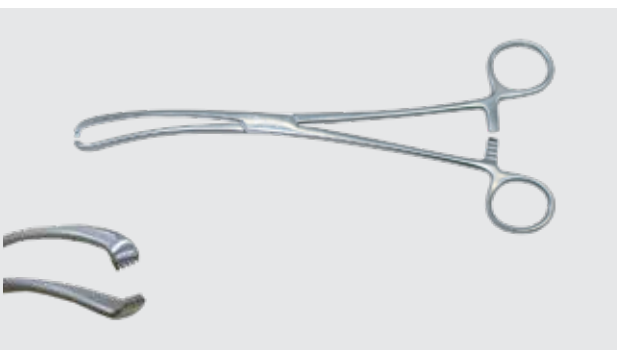

Kelly Tenaculum

- 031017 Kelly Tenaculum 4X5 Teeth, 9" (229mm)



Atraumatic Tenaculum

- 031001 Atraumatic Straight 1/4" (6mm) Jaws, 9" (229mm)
- 031002 Atraumatic Straight 1/8" (3mm) Jaws, 9" (229mm)
- 031003 Atraumatic Angled 1/4" (6mm) Jaws, 9 1/2" (241mm)



Shah Tenaculum

- 031016 Shah Tenaculum 9 1/2" (241mm)



Iris Hook

- 030406 Iris Hook 10" (254mm)



Emmett Tenaculum Hooks

- 031401 Emmett Curved Hook 9 1/2" (241mm)
- 031402 Emmett Half-Curved Hook 9 3/4" (248mm)
- 031403 Emmett Hook L-Shaped 9" (229mm)
- 031404 Emmett Hook Acute Angle 9" (229mm)
- 031405 Emmett Hook Double Angled 9" (229mm)



MedGyn Needle Adapters - Extenders

An effective means of extending ordinary hypodermic needles when longer needles are required. The paracervical and uterosacral areas can easily be reached with an extended needle.

Needle Adapters

- 030501 Needle Adapter 3" (76mm)
- 030502 Needle Adapter 4" (102mm)
- 030503 Needle Adapter 5" (127mm)
- 030504 Needle Adapter 6" (152mm)



MedGyn Blue Titanium

Classic Tischler bite with durable coating.
Bite Size: 7mm x 3mm

- 030176 Tischler Biopsy Punch Blue Titanium Heavy-Grip Handle 10" (254mm)
- 030181 Tischler Biopsy Punch Blue Titanium 10" (254mm)
- 030128 Tischler Biopsy Punch Blue Titanium 8½" (216mm)



Baby Tischler Biopsy Punch

Smaller bite size designed for less trauma with durable coating. Bite Size: 4.2mm x 2.3mm

- 030177 Baby Tischler Biopsy Punch Blue Titanium Heavy-Grip Handle 10" (254mm)
- 030129 Baby Tischler Biopsy Punch Blue Titanium 8½" (216mm)
- 030180 Baby Tischler Biopsy Punch Blue Titanium 10" (254mm)



Baby Tischler Biopsy Punch (Forceps Style)

Smaller bite size designed for less trauma with durable coating. Bite Size: 4.2mm x 2.3mm

- 030179 Baby Tischler Biopsy Punch Blue Titanium Gold Handle (Forceps Style) 10" (254mm)



Kevorkian Biopsy Punch

Popular design with strong, narrow jaw with durable coating and a heavy-grip handle. Bite Size: 8mm x 3mm

- 030178 Kevorkian Biopsy Punch Blue Titanium Heavy-Grip Handle 10" (254mm)



Oval Tischler Biopsy Punch

Oval Tischler bite with durable coating and a heavy-grip handle.

- 030175 Oval Tischler Biopsy Punch Blue Titanium Heavy-Grip Handle 10" (254mm)



MedGyn Gold Titanium

- 030182 Tischler Biopsy Punch Gold Titanium (250mm)
- 030183 Tischler Biopsy Punch, Gold Titanium (200mm)
- 030184 Baby Tischler Biopsy Punch Gold Titanium (250mm)
- 030185 Baby Tischler Biopsy Punch Gold Titanium (200mm)
- 030186 Kevorkian Biopsy Punch Gold Titanium (250mm)
- 030187 Kevorkian Biopsy Punch Gold Titanium (200mm)



MedGyn Titanium

Tischler Biopsy Punch

Classic Tischler bite, with durable coating.

Bite Size: 7mm x 3mm

- 030172 Tischler Biopsy Punch Titanium 10" (254mm) Heavy-Grip Handle
- 030120 Tischler Biopsy Punch Titanium 10" (254mm)
- 030124 Tischler Biopsy Punch Titanium 10" (254mm)-Angled Up
- 030125 Tischler Biopsy Punch Titanium 10" (254mm)-Angled Down
- 030162 Tischler Biopsy Punch Titanium 10" (254mm)-Angled Left
- 030163 Tischler Biopsy Punch Titanium 10" (254mm)-Angled Right
- 030118 Tischler Biopsy Punch Titanium 8½" (216mm)
- 030122 Tischler Biopsy Punch Titanium 8½" (216mm)-Angled Up
- 030123 Tischler Biopsy Punch Titanium 8½" (216mm)-Angled Down
- 030138 Tischler Biopsy Punch Titanium 8½" (216mm)-Angled Right
- 030139 Tischler Biopsy Punch Titanium 8½" (216mm)-Angled Left



Baby Tischler Biopsy Punch (Forceps Style)

Classic Baby Tischler bite with durable coating. Bite Size: 4.2mm x 2.3mm

- 030170 Baby Tischler Biopsy Punch Titanium Gold Handle (Forceps Style) 10" (254mm)



Oval Tischler Biopsy Punch

- 030171 Oval Tischler Biopsy Punch Titanium Heavy-Grip Handle 10" (254mm)



Kevorkian Biopsy Punch

Popular design with strong, narrow jaw with durable coating. Bite Size: 8mm x 3mm.

- 030174 Kevorkian Biopsy Punch Titanium Heavy-Grip Handle 10" (254mm)
- 030127 Kevorkian Biopsy Punch Titanium 10" (254mm)
- 030126 Kevorkian Biopsy Punch Titanium 8½" (216mm)



Baby Tischler Biopsy Punch

Smaller bite size designed for less trauma with durable coating. Bite Size: 4.2mm x 2.3mm

- 030173 Baby Tischler Biopsy Punch Titanium 10" (254mm) Heavy-Grip Handle
- 030121 Baby Tischler Biopsy Punch Titanium 10" (254mm)
- 030134 Baby Tischler Biopsy Punch Titanium 10" (254mm) - Angled Up
- 030135 Baby Tischler Biopsy Punch Titanium 10" (254mm) - Angled Down
- 030161 Baby Tischler Biopsy Punch Titanium 10" (254mm) - Angled Left
- 030160 Baby Tischler Biopsy Punch Titanium 10" (254mm) - Angled Right
- 030119 Baby Tischler Biopsy Punch Titanium 8½" (216mm)
- 030132 Baby Tischler Biopsy Punch Titanium 8½" (216mm) - Angled Up
- 030133 Baby Tischler Biopsy Punch Titanium 8½" (216mm) - Angled Down
- 030159 Baby Tischler Biopsy Punch Titanium 8½" (216mm) - Left
- 030158 Baby Tischler Biopsy Punch Titanium 8½" (216mm) - Right



MedGyn Stainless Steel

Tischler Biopsy Punch

Classic Tischler bite designed for drawing in maximum tissue near Os with minimal trauma.

Bite Size 7mm x 3mm

- 030101-10 Tischler Biopsy Punch 10" (254mm)
- 029801 Tischler Biopsy Punch 10" (254mm) Angled Up
- 029802 Tischler Biopsy Punch 10" (254mm) Angled Down
- 029803 Tischler Biopsy Punch 10" (254mm) Angled Left
- 029804 Tischler Biopsy Punch 10" (254mm) Angled Right
- 030101 Tischler Biopsy Punch 8½" (216mm)
- 030113 Tischler Biopsy Punch 8½" (216mm) Angled Up
- 030114 Tischler Biopsy Punch 8½" (216mm) Angled Down
- 030136 Tischler Biopsy Punch 8½" (216mm) Angled Left
- 030137 Tischler Biopsy Punch 8½" (216mm) Angled Right



Baby Tischler Biopsy Punch

Smaller bite size designed for less trauma.

Bite Size: 4.2mm x 2.3mm

- 030102-10 Baby Tischler Biopsy Punch 10" (254mm)
- 029811 Baby Tischler Biopsy Punch 10" (254mm) Angled Up
- 029812 Baby Tischler Biopsy Punch 10" (254mm) Angled Down
- 029813 Baby Tischler Biopsy Punch 10" (254mm) Angled Left
- 029814 Baby Tischler Biopsy Punch 10" (254mm) Angled Right
- 030102 Baby Tischler Biopsy Punch 8½" (216mm)
- 030140 Baby Tischler Biopsy Punch 8½" (216mm) Angled Up
- 030141 Baby Tischler Biopsy Punch 8½" (216mm) Angled Down
- 030142 Baby Tischler Biopsy Punch 8½" (216mm) Angled Left
- 030143 Baby Tischler Biopsy Punch 8½" (216mm) Angled Right

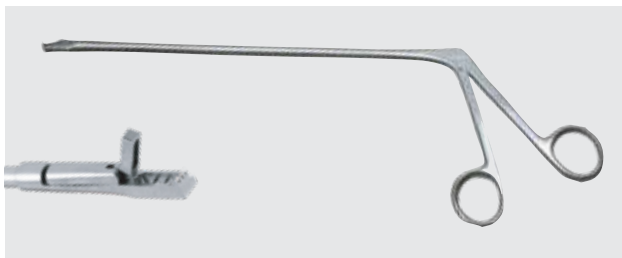

Kevorkian Biopsy Punch

(Kevorkian-Younger Biopsy Forceps displayed)

- 030103-10 Kevorkian Biopsy Punch 10" (254mm)
- 030103 Kevorkian Biopsy Punch 8½" (216mm)
- 030169 Kevorkian-Younger Biopsy Forceps without Spring 8" (203mm)



Tischler-Kevorkian Cervical Biopsy Punch

- 030116 Tischler-Kevorkian Biopsy Punch 10" (254mm)
- 030115 Tischler-Kevorkian Biopsy Punch 8½" (216mm)

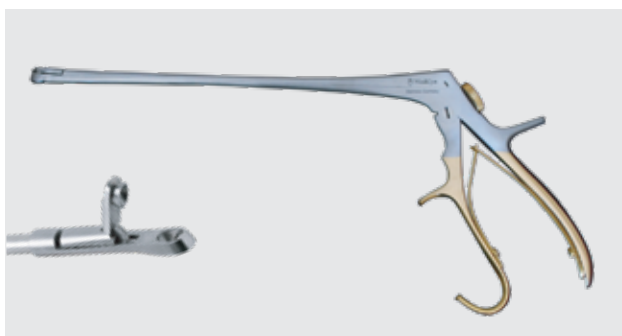

Burke Biopsy Punch

Open-handle design for optimal control with small cutting jaws and sharp teeth.

- 030109 Burke Biopsy Punch 8½"



Eppendorfer Biopsy Forceps

- 030110 Eppendorfer Biopsy Forceps 8" (203mm)



Van Doren Biopsy Forceps

- 030155 Van Doren Biopsy Forceps with Ratchet 10" (254mm)
- 030166 Van Doren Biopsy Forceps without Ratchet 10" (254mm)



Schubert Biopsy Forceps

- 030157 Schubert Biopsy Forceps 10" (254mm) Curved



Wittner Biopsy Punch

- 030117 Wittner Biopsy Punch 8½" (216mm)



Rotating Biopsy Punch Options

- 030778 Vulvar Keyes Biopsy Punch Set (Handle + 6 Tips)
- 030104 Rotating Tischler Biopsy Punch
- 030145 Rotating Tischler Biopsy Punch - Angled Down
- 030146 Rotating Tischler Biopsy Punch - Angled Up
- 030105 Rotating Baby Tischler Biopsy Punch
- 030105-DOWN Rotating Baby Tischler Biopsy Punch - Angled Down
- 030105-UP Rotating Baby Tischler Biopsy Punch - Angled Up
- 030106 Rotating Kevorkian Biopsy Punch
- 030107 Rotating Burke Biopsy Punch
- 030111-BB Rotating Shaft - Baby Tischler Tip Only
- 030111-BRK Rotating Shaft - Burke Tip Only
- 030111-KEV Rotating Shaft - Kevorkian Tip Only
- 030111-TIS Rotating Shaft - Tischler Tip Only
- 030147 Rotating Shaft - Tischler Tip - Up
- 030148 Rotating Shaft - Tischler Tip - Down
- 030108 Rotating Biopsy Punch Handle Only
- 030100 Rotating Shaft (with any tip)

MedGyn Lletz Instruments - Blue Coated

All MedGyn Lletz instruments have a durable coating to insulate against transmission of electric current, ensuring the highest level of protection for patients and physicians.



Graves Speculum Closed Tube

- 038030 Small, 3/4" x 3" (19mm x 76mm)
- 038031 Medium, 1 3/8" x 4" (35mm x 102mm)
- 038032 Large, 1 3/8" x 4 3/4" (35mm x 121mm)
- 038033 Extra Large, 1 1/2" x 6 1/2" (38mm x 165mm)
- 030900-LTZ Extra Long Snowman, Clinton 1 1/2" x 6" (38mm x 152mm)



Graves Vu-More Speculum Closed Tube

- 038055 Medium 1 1/4" x 4" (32mm x 102mm)
- 038056 Large 1 3/8" x 4 1/2" (35mm x 114mm)



Graves Vu-Max Speculum Closed Tube

- 038046 Large 1 3/8" x 4 1/2" (35mm x 114mm)



Graves Vu-More Speculum, (40mm) Open Channel

- 038115 Small 3 7/8" (98mm)
- 038116 Medium 4 1/2" (114mm)
- 038117 Large 4 7/8" (124mm)
- 038118 Extra Large 5 7/8" (149mm)
- 038119 Extra Large 6 1/3" (161mm)
- 038120 Extra Large 6 2/3" (169mm)
- 038121 Extra Large 7" (178mm)



Graves Vu-Max Speculum, (70mm) Open Channel

- 038125 Small 3 7/8" (98mm)
- 038126 Medium 4 1/2" (114mm)
- 038127 Large 4 7/8" (124mm)
- 038128 Extra Large 5 7/8" (149mm)
- 038129 Extra Large 6 1/3" (161mm)
- 038130 Extra Large 6 2/3" (169mm)
- 038131 Extra Large 7" (178mm)



Pederson Speculum Closed Tube

- 038040 Small, 1/2" x 3" (13mm x 76mm)
- 038041 Medium, 7/8" x 4" (22mm x 102mm)
- 038042 Large, 1" x 4 3/4" (25mm x 121mm)
- 038043 Extra Large, 1" x 6 1/2" (25mm x 165mm)
- 030917-LTZ Extra Long Snowman Clinton, 1" x 6" (25mm x 152mm)
- 038044 Medium, Right Side Open, 7/8" x 4" (22mm x 102mm)
- 038044-LT Medium, Left Side Open, 7/8" x 4" (22mm x 102mm)
- 038045 Large, Right Side Open, 1" x 4 3/4" (25mm x 121mm)
- 038045-LT Large, Left Side Open, 1" x 4 3/4" (25mm x 121mm)



Pederson Vu-More Speculum, (40mm) Open Channel

- 038100 Medium 4½" (114mm)
- 038101 Large 4⅞" (124mm)
- 038102 Extra Large 5⅞" (149mm)



Pederson Vu-Max Speculum, (70mm) Open Channel

- 038110 Medium 4½" (114mm)
- 038111 Large 4⅞" (124mm)
- 038112 Extra Large 5⅞" (149mm)



Weisman Open Side Speculum Closed Tube

- 038050 Right Side Open Medium 1⅜" x 4" (35mm x 102mm)
- 038050-ANG Right Side Open Medium Angled 1⅜" x 4" (35mm x 102mm)
- 038052 Right Side Open Large 1⅜" x 4¾" (35mm x 121mm)
- 038052-ANG Right Side Open Large Angled 1⅜" x 4¾" (35mm x 121mm)
- 038051 Left Side Open Medium 1⅜" x 4" (35mm x 102mm)
- 038051-ANG Left Side Open Medium Angled 1⅜" x 4" (35mm x 102mm)
- 038053 Left Side Open Large 1⅜" x 4¾" (35mm x 121mm)
- 038053-ANG Left Side Open Large Angled 1⅜" x 4¾" (35mm x 121mm)



Collins Speculum Closed Tube

- 038047 Small 1¼" x 3¾" (32mm x 95mm)
- 038048 Medium 1⅜" x 4" (35mm x 102mm)
- 038049 Large 1⅝" x 4½" (41mm x 114mm)



Four-Way Lateral Speculum Open Channel

- 038093 Medium ⅞" x 4¼" (22mm x 108mm)
- 038094 Large ⅞" x 5¼" (22mm x 133mm)

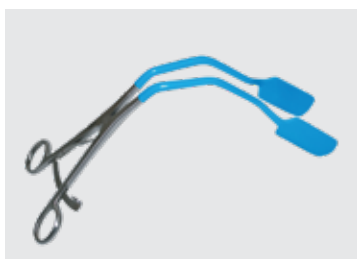

Lateral Vaginal Wall Retractor

- 038060 Closed, 10" (254mm), Blade Size 1" x 2½" (25mm x 64mm)
- 038061 Open ½" (13mm) 10" (254mm), Blade Size 1" x 2½" (25mm x 64mm)
- 038062 Open 1" (25mm) 10" (254mm) Blade Size 1" x 2½" (25mm x 64mm)
- 038063 Wide Open, 10" (254mm) Blade Size 1" x 2½" (25mm x 64mm)



Klopper Speculum Closed Tube

- 038054 1⅜" x 3½" (35mm x 89mm)

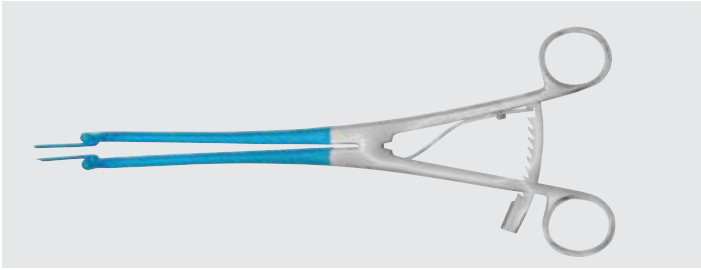

Lletz Kogan Endocervical Speculum

038057 Speculum 2-4mm, 11" (279mm)

038058 Speculum 4-8mm, 11" (279mm)

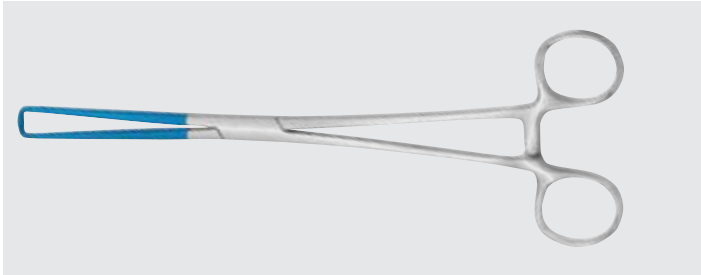
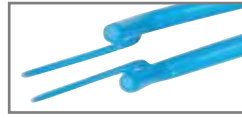

Lletz Tenaculum

038070 Single-Tooth Tenaculum 9¾" (248mm)

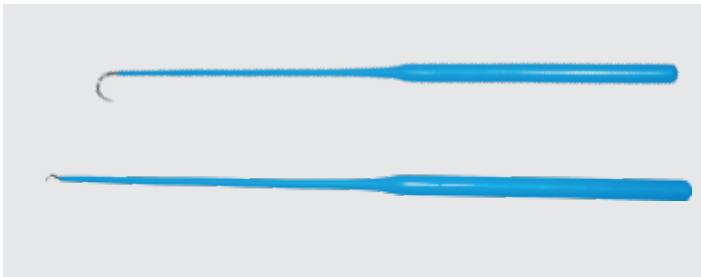
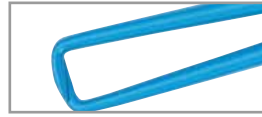

Lletz Tenaculum Hook

038080 Emmet Tenaculum 9" (229mm)

038081 Iris Tenaculum Hook 9" (229mm)

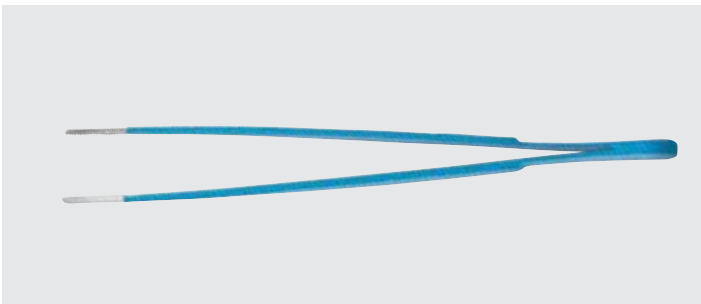

Lletz Dressing Forceps

038082 Lletz Dressing Forceps Small 8" (203mm)

038092 Lletz Dressing Forceps Large 10" (254mm)



Lletz Tissue Forceps

038090 Lletz Tissue Forceps Small 8" (203mm)

038091 Lletz Tissue Forceps Large 10" (254mm)

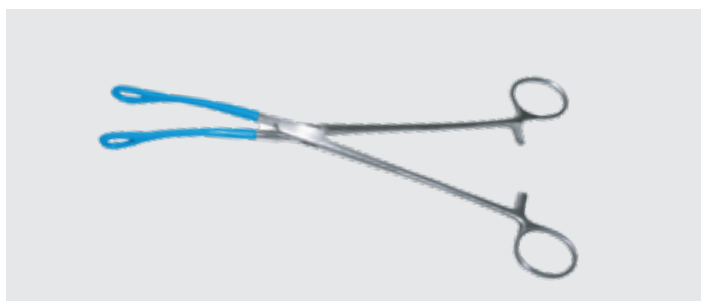
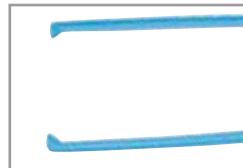

Lletz Foerster Forceps

038071 Lletz Foerster Forceps - Straight 9½" (241mm)

038072 Lletz Foerster Forceps - Curved 9½" (241mm)

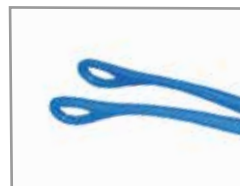

MedGyn Double-End Dilators



Pratt Dilator

Stainless steel double-end dilator 11½" (292mm).

- 030850 Pratt 8 Piece Dilator Set 13-15 Fr - 41-43 Fr
- 030850-ECO Pratt 8 Piece Dilator Set 13-15 Fr -41-43 Fr
- 030859 Pratt Dilator 9-11Fr
- 030851 Pratt Dilator 13-15 Fr
- 030852 Pratt Dilator 17-19 Fr
- 030853 Pratt Dilator 21-23 Fr
- 030854 Pratt Dilator 25-27 Fr
- 030855 Pratt Dilator 29-31 Fr
- 030856 Pratt Dilator 33-35 Fr
- 030857 Pratt Dilator 37-39 Fr
- 030858 Pratt Dilator 41-43 Fr



Hank Dilator

Designed with guide rings for ease-of-use 11" (279mm)

- 030801 Hank 6 Piece Dilator Set 11-12 Fr - 21-22 Fr
- 030801-7 Hank 7 Piece Dilator Set 9-10 Fr - 21-22 Fr
- 030801-7/8 Hank Dilator 7-8 Fr
- 030801-9/10 Hank Dilator 9-10 Fr
- 030801-11/12 Hank Dilator 11-12 Fr
- 030801-13/14 Hank Dilator 13-14 Fr
- 030801-15/16 Hank Dilator 15-16 Fr
- 030801-17/18 Hank Dilator 17-18 Fr
- 030801-19/20 Hank Dilator 19-20 Fr
- 030801-21/22 Hank Dilator 21-22 Fr



Pratt Extra Large Dilator

Pratt style in larger sizes 11½" (292mm).

- 030870 Pratt Extra Large 9 Piece Dilator Set 45-47 Fr - 77-79 Fr
- 030870-ECO Pratt Extra Large 9 Piece Dilator Set 45-47 Fr - 77-79 Fr
- 030871 Pratt Dilator Extra Large 45-47 Fr
- 030872 Pratt Dilator Extra Large 49-51 Fr
- 030873 Pratt Dilator Extra Large 53-55 Fr
- 030874 Pratt Dilator Extra Large 57-59 Fr
- 030875 Pratt Dilator Extra Large 61-63 Fr
- 030876 Pratt Dilator Extra Large 65-67 Fr
- 030877 Pratt Dilator Extra Large 69-71 Fr
- 030878 Pratt Dilator Extra Large 73-75 Fr
- 030879 Pratt Dilator Extra Large 77-79 Fr
- 030880 Pratt Extra Large, Light Weight 9 Piece Dilator Set 45-47 Fr - 77-79 Fr
- 030881 Pratt Extra Large, Light Weight 45-47 Fr
- 030882 Pratt Extra Large, Light Weight 49-51 Fr
- 030883 Pratt Extra Large, Light Weight 53-55 Fr
- 030884 Pratt Extra Large, Light Weight 57-59 Fr
- 030885 Pratt Extra Large, Light Weight 61-63 Fr
- 030886 Pratt Extra Large, Light Weight 65-67 Fr
- 030887 Pratt Extra Large, Light Weight 69-71 Fr
- 030888 Pratt Extra Large, Light Weight 73-75 Fr
- 030889 Pratt Extra Large, Light Weight 77-79 Fr



Hegar Dilator

Stainless steel double-end dilator 7½" (191mm).

- 030830 Hegar 8 Piece Dilator Set 3-4mm - 17-18mm
- 030831 Hegar Dilator 1-2mm
- 030832 Hegar Dilator 3-4mm
Hegar Dilator 5-6mm
- 030834 Hegar Dilator 7-8mm
- 030835 Hegar Dilator 9-10mm
- 030836 Hegar Dilator 11-12mm
- 030837 Hegar Dilator 13-14mm
- 030838 Hegar Dilator 15-16mm
- 030839 Hegar Dilator 17-18mm

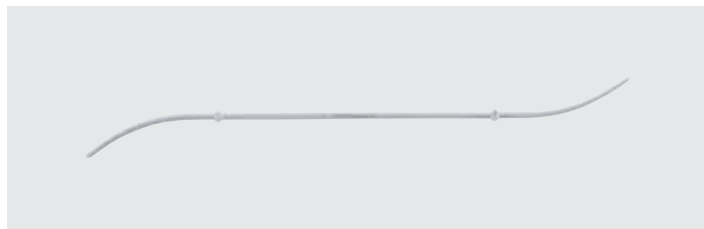

Kleegman Dilator

Double-end dilator available in stainless steel and Teflon™. (Stainless steel pictured) (1.0mm/2.0mm)

- 030804 Kleegman Stainless Steel Dilator 11" (279mm)
- 030805 Kleegman Teflon™ Dilator 12" (305mm)

MedGyn Single-End Dilators

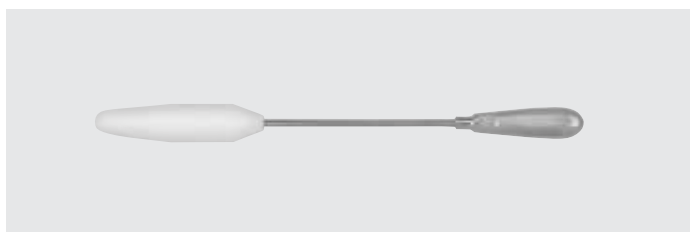

Hern Dilator

Teflon single-end dilator with handle 14¾" (375mm).

- 030807 Hern 21 Piece Dilator Set Sizes 44 Fr - 104 Fr
- 030808 Hern Dilator 44 Fr
- 030809 Hern Dilator 47 Fr
- 030810 Hern Dilator 50 Fr
- 030811 Hern Dilator 53 Fr
- 030812 Hern Dilator 56 Fr
- 030813 Hern Dilator 59 Fr
- 030814 Hern Dilator 62 Fr
- 030815 Hern Dilator 65 Fr
- 030816 Hern Dilator 68 Fr
- 030817 Hern Dilator 71 Fr
- 030818 Hern Dilator 74 Fr
- 030819 Hern Dilator 77 Fr
- 030820 Hern Dilator 80 Fr
- 030821 Hern Dilator 83 Fr
- 030822 Hern Dilator 86 Fr
- 030823 Hern Dilator 89 Fr
- 030824 Hern Dilator 92 Fr
- 030825 Hern Dilator 95 Fr
- 030826 Hern Dilator 98 Fr
- 030827 Hern Dilator 101 Fr
- 030828 Hern Dilator 104 Fr
- 030829-107 Hern Dilator 107 Fr
- 030829-110 Hern Dilator 110 Fr
- 030829-113 Hern Dilator 113 Fr

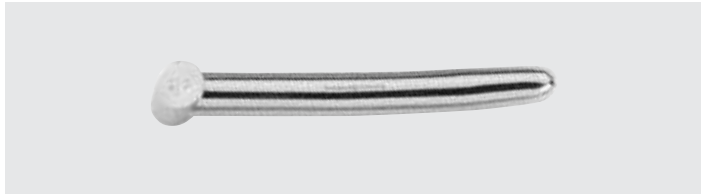

Hawkin Ambler

Stainless steel single-end, dilator 7¼" (184mm).

- 030780 16 Piece Dilator Set Sizes 3-6mm - 18-21mm
- 030781 Hawkin Ambler Dilator 3-6mm
- 030782 Hawkin Ambler Dilator 4-7mm
- 030783 Hawkin Ambler Dilator 5-8mm
- 030784 Hawkin Ambler Dilator 6-9mm

- 030785 Hawkin Ambler Dilator 7-10mm
- 030786 Hawkin Ambler Dilator 8-11mm
- 030787 Hawkin Ambler Dilator 9-12mm
- 030788 Hawkin Ambler Dilator 10-13mm
- 030789 Hawkin Ambler Dilator 11-14mm
- 030790 Hawkin Ambler Dilator 12-15mm
- 030791 Hawkin Ambler Dilator 13-16mm
- 030792 Hawkin Ambler Dilator 14-17mm
- 030793 Hawkin Ambler Dilator 15-18mm
- 030794 Hawkin Ambler Dilator 16-19mm
- 030795 Hawkin Ambler Dilator 17-20mm
- 030796 Hawkin Ambler Dilator 18-21mm



Hegar Dilator

Stainless steel single-end dilator 7½" (191mm).

- 030841-1 Hegar Dilator 1mm
- 030841-1.5 Hegar Dilator 1.5mm
- 030841-2 Hegar Dilator 2mm
- 030841-2.5 Hegar Dilator 2.5mm
- 030841-3 Hegar Dilator 3mm
- 030841-3.5 Hegar Dilator 3.5mm
- 030841-4 Hegar Dilator 4mm
- 030841-4.5 Hegar Dilator 4.5mm
- 030841-5 Hegar Dilator 5mm
- 030841-5.5 Hegar Dilator 5.5mm
- 030842-6 Hegar Dilator 6mm
- 030842-6.5 Hegar Dilator 6.5mm
- 030842-7 Hegar Dilator 7mm
- 030842-7.5 Hegar Dilator 7.5mm
- 030842-8 Hegar Dilator 8mm
- 030842-8.5 Hegar Dilator 8.5mm
- 030842-9 Hegar Dilator 9mm
- 030842-9.5 Hegar Dilator 9.5mm

- 030842-10 Hegar Dilator 10mm
- 030842-10.5 Hegar Dilator 10.5mm
- 030843-11 Hegar Dilator 11mm
- 030843-11.5 Hegar Dilator 11.5mm
- 030843-12 Hegar Dilator 12mm
- 030843-12.5 Hegar Dilator 12.5mm
- 030843-13 Hegar Dilator 13mm
- 030843-13.5 Hegar Dilator 13.5mm
- 030843-14 Hegar Dilator 14mm
- 030843-14.5 Hegar Dilator 14.5mm
- 030843-15 Hegar Dilator 15mm
- 030843-15.5 Hegar Dilator 15.5mm
- 030844-16 Hegar Dilator 16mm
- 030844-16.5 Hegar Dilator 16.5mm
- 030844-17 Hegar Dilator 17mm
- 030844-17.5 Hegar Dilator 17.5mm
- 030844-18 Hegar Dilator 18mm
- 030844-18.5 Hegar Dilator 18.5mm



Pratt Dilator Plastic

Light-weight, reusable 5 piece plastic dilator set.

- 030890 Pratt Dilator Plastic 5 Piece Set 5-6mm-13-14mm

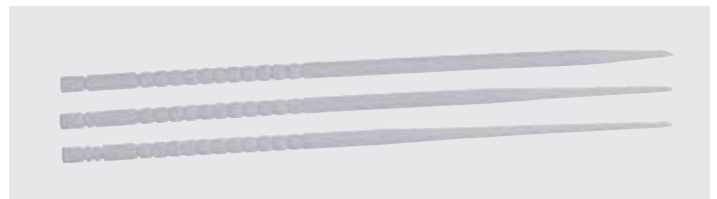

Os Cervical Finder Set

Made of soft, malleable reusable material. 3 piece set (Os Finder, Canal Finder & Fundus Finder)

- 030803 Os Cervical Finder 3 Piece Set



Mini Dilator Set

6 piece set (5 dilators & handle).

030779 6 Piece Mini Dilator Set:
1mm, 1.5mm, 2mm, 2.5mm, 3mm



030779BT Mini Dilator Set Blue Titanium



McMahan Cervico Meter

Angled, used for measuring dilation of cervix.

031300 McMahan Cervico Meter

MedGyn Endometrial Curettes



Sims Curette

Metal curette with sharp blade on malleable or rigid shanks 11" (279mm).

- | | | | |
|--------|---|--------|---|
| 030640 | Sims Malleable Curette 8 Piece Set Sizes #00 - #6 | 030639 | Sims Malleable Curette #10 |
| 030640 | 12 Sims Malleable Curette 12 Piece Set Sizes #00-10 | 030650 | Sims Rigid Curette 8 Piece Set Sizes #00 - #6 |
| 030641 | Sims Malleable Curette #00 | 030651 | Sims Rigid Curette #00 |
| 030642 | Sims Malleable Curette #0 | 030652 | Sims Rigid Curette #0 |
| 030643 | Sims Malleable Curette #1 | 030653 | Sims Rigid Curette #1 |
| 030644 | Sims Malleable Curette #2 | 030654 | Sims Rigid Curette #2 |
| 030645 | Sims Malleable Curette #3 | 030655 | Sims Rigid Curette #3 |
| 030646 | Sims Malleable Curette #4 | 030656 | Sims Rigid Curette #4 |
| 030647 | Sims Malleable Curette #5 | 030657 | Sims Rigid Curette #5 |
| 030648 | Sims Malleable Curette #6 | 030658 | Sims Rigid Curette #6 |
| 030649 | Sims Malleable Curette #7 | 030659 | Sims Rigid Curette #7 |
| 030637 | Sims Malleable Curette #8 | 030660 | Sims Rigid Curette #8 |
| 030638 | Sims Malleable Curette #9 | 030661 | Sims Rigid Curette #9 |
| | | 030662 | Sims Rigid Curette #10 |

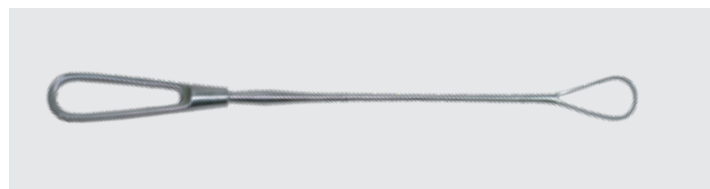

Bumm Curette

Extra-large metal curettes on malleable shanks

- | | |
|--------|---|
| 030620 | 4 Piece Set - Sizes #1 - #4 12" (305mm) |
| 030621 | Bumm - Size #1 12" (305mm) |
| 030622 | Bumm - Size #2 12" (305mm) |
| 030623 | Bumm - Size #3 12" (305mm) |
| 030624 | Bumm - Size #4 12" (305mm) |



Banjo/Hunter Curette

- | | |
|--------|--|
| 030619 | Banjo/Hunter Curette Size 14 - 30mm 13½" (343mm) |
|--------|--|



Heaney Curette

- | | |
|--------|----------------------------------|
| 030680 | Heaney Curette Small 9½" (241mm) |
|--------|----------------------------------|

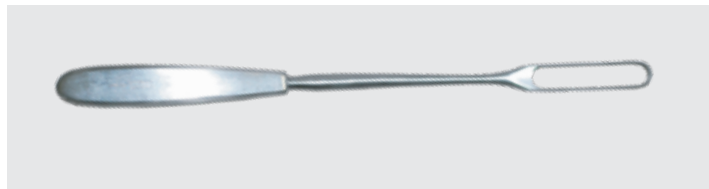

Evans Curette

- 030630 Evans Curette 6 Piece Set Sizes #0 - #5
11" (279mm)
- 030631 Evans Curette #0-4mm 11" (279mm)
- 030632 Evans Curette #1-6mm 11" (279mm)
- 030633 Evans Curette #2-8mm 11" (279mm)
- 030634 Evans Curette #3-10mm 11" (279mm)
- 030635 Evans Curette #4-12mm 11" (279mm)
- 030636 Evans Curette #5-14mm 11" (279mm)

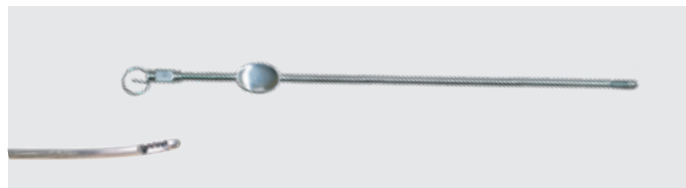

Novak Curette

Popular metal curette available in a 3 piece set or in individual sizes.

- 030600 Novak Curette 3 Piece Set 2mm - 4mm 9³/₄"
(248mm)
- 030602 Novak Curette 2mm 9³/₄" (248mm)
- 030603 Novak Curette 3mm 9³/₄" (248mm)
- 030604 Novak Curette 4mm 9³/₄" (248mm)

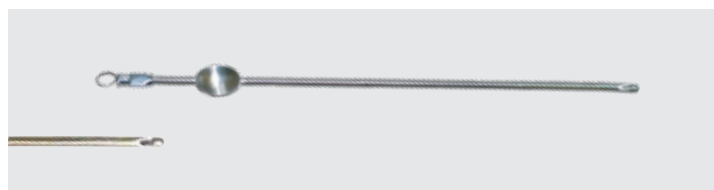

Randall Curette

- 030610 Randall Curette 3 Piece Set #2 - #4 9³/₄" (248mm)
- 030612 Randall Curette #1 9³/₄" (248mm)
- 030613 Randall Curette #2 9³/₄" (248mm)
- 030614 Randall Curette #3 9³/₄" (248mm)

MedGyn Endocervical Curettes



Kevorkian-Youngue
w/o Basket



Kevorkian-Youngue
with Basket

Kevorkian-Youngue Curette

Metal curette available with or without basket.

- 030301 Kevorkian-Youngue Malleable Curette w/o Basket 12" (305mm)
- 030302 Kevorkian-Youngue Malleable Curette with Basket 12" (305mm)
- 030303 Kevorkian-Youngue Rigid Curette w/o Basket 12" (305mm)
- 030304 Kevorkian-Youngue Rigid Curette with Basket 12" (305mm)
- 030303-H Kevorkian-Youngue Rigid Curette w/o Basket (Square Tip, Gold Handle, Heavy) 12" (305mm)
- 030304-H Kevorkian-Youngue Rigid Curette with Basket (Square Tip, Gold Handle, Heavy) 12" (305mm)
- 030315 Kevorkian-Youngue Rigid Curette w/o Basket (Square Tip, Titanium) 12" (305mm)
- 030311 Kevorkian-Youngue Rigid Curette with Basket (Square Tip, Titanium) 12" (305mm)
- 030306 Kevorkian-Youngue Rigid Curette with Basket (Round Tip, Gold Handle, Heavy) 12" (305mm)
- 030310 Kevorkian-Youngue Rigid Curette with Basket (Round Tip, Titanium) 12" (305mm)



Townsend Curette

Round, tapered tip allows for entry through stenotic os.

- 030305 Townsend Curette 12" (305mm)

Metal Uterine Sounds



- 030704 Simpson Uterine Sound 3mm Diameter, Graduated in inches, 13" (330mm)
- 030705 Simpson Uterine Sound 3mm Diameter, Graduated in cm, 13" (330mm)

Sims Uterine Sound



- 030700 Sims Uterine Sound 3mm Diameter, Graduated in inches, 13" (330mm)
- 030701 Sims Uterine Sound 3mm Diameter, Graduated in cm, 13" (330mm)
- 030702 Sims Uterine Sound 2mm Diameter, Graduated in cm, 13" (330mm)
- 030703 Sims Uterine Sound 3mm Plain Probe, Malleable, 13" (330mm)

MedGyn Ovum Forceps

Sopher Ovum Forceps

Slightly curved forceps with oval, serrated jaws.



- 031123 Sopher Ovum Forceps 11" (279mm) 12mm Jaws
- 031123R Sopher Ovum Forceps 11" (279mm) 12mm Jaws with Ratchet
- 031126 Sopher Ovum Forceps 11" (279mm) 14mm Jaws
- 031149 Sopher Ovum Forceps 11" (279mm) 14mm Jaws with Ratchet
- 031124 Sopher Ovum Forceps 13" (330mm) 12mm Jaws
- 031125 Sopher Ovum Forceps 13" (330mm) 12mm Jaws with Ratchet
- 031127 Sopher Ovum Forceps 13" (330mm) 14mm Jaws
- 031128 Sopher Ovum Forceps 13" (330mm) 14mm Jaws with Ratchet

Bierer Ovum Forceps

Slightly curved forceps with oval, coarse, serrated jaws.



- 031131 Bierer Ovum Forceps 11"(279mm) 16mm Jaws
- 031132 Bierer Ovum Forceps 11"(279mm) 16mm Jaws with Ratchet
- 031135 Bierer Ovum Forceps 11" (279mm) 19mm Jaws
- 031136 Bierer Ovum Forceps 11" (279mm) 19mm Jaws with Ratchet
- 031133 Bierer Ovum Forceps 13" (330mm) 16mm Jaws
- 031134 Bierer Ovum Forceps 13" (330mm) 16mm Jaws with Ratchet
- 031137 Bierer Ovum Forceps 13" (330mm) 19mm Jaws
- 031138 Bierer Ovum Forceps 13" (330mm) 19mm Jaws with Ratchet

Sopher Original Forceps

Slightly curved forceps with oval jaw. Concave tip design to prevent grasping of fundus.



- 031129 Sopher Original Forceps 10½" (267mm) Small Jaws
- 031130 Sopher Original Forceps 10½" (267mm) Medium Jaws

Hern Evacuation Forceps

Slightly curved forceps with coarse teeth, oval jaws.



- 031146 Hern Evacuation Forceps 13" (330mm) Small 12mm Jaws
- 031147 Hern Evacuation Forceps 13" (330mm) Medium 15mm Jaws
- 031148 Hern Evacuation Forceps 13" (330mm) Large 19mm Jaws



Hern-Patterson Forceps

Straight forceps with coarse teeth, oval jaws and ratchet.

031139 Hern Patterson Evacuation Forceps 13" (330mm) 17mm Jaws

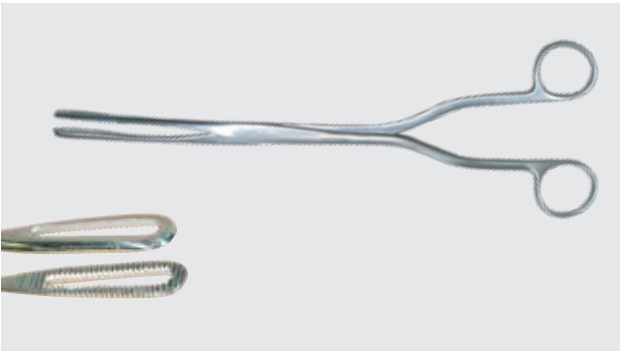

Hern Van-Lyth Forceps

Curved forceps with fine teeth.

031166 Hern Van Lyth Evacuation Forceps 9½" (241mm) 9mm Jaws

031167 Hern Van Lyth Evacuation Forceps 10" (254mm) 11mm Jaws

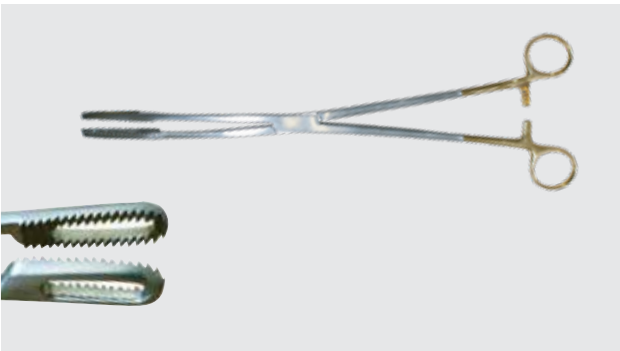

Agadi-Bierer Forceps

031153 Agadi-Bierer Forceps 13" (330mm) - 14mm without Ratchet

031154 Agadi-Bierer Forceps 13" (330mm) - 14mm with Ratchet

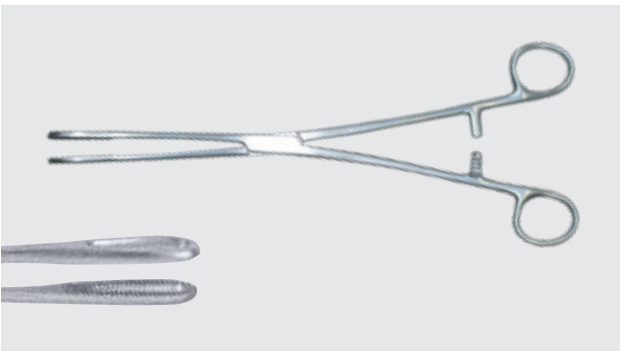

Ramplly Ring Forceps

031007 Ramplly with Oval Jaws 10" (254mm) Straight

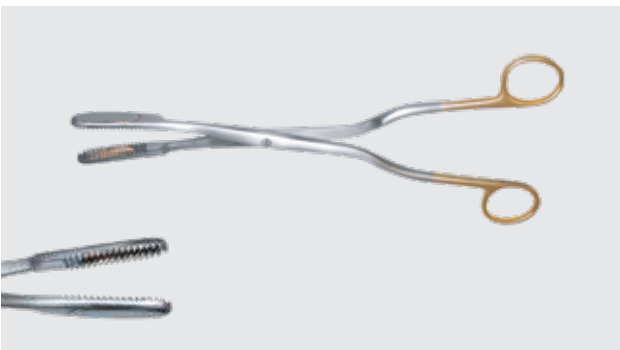

West-Gluck Forceps

031168 West-Gluck Forceps 11" (279mm)

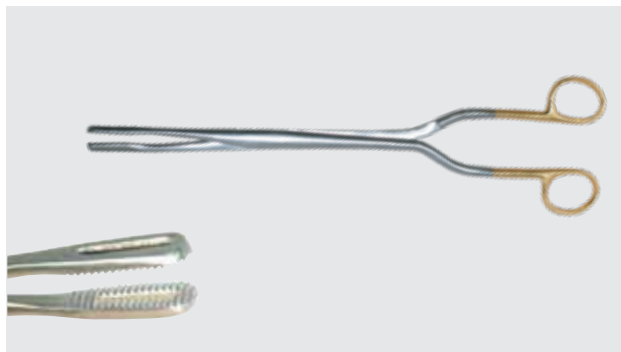

Stubblefield Forceps

Slightly curved, very long forceps with oval jaws.

031144 Stubblefield Forceps 15" (381mm) 14mm Jaws

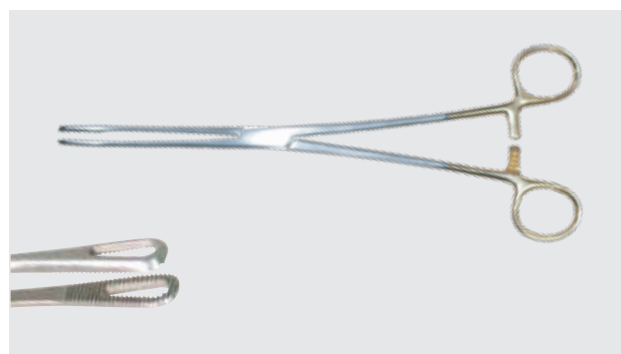

Agadi Evacuation Forceps

Smaller forceps available in both straight and curved versions with oval jaws.

031170 Agadi Evacuation Forceps 9¾" (248mm) Curved

031171 Agadi Evacuation Forceps 9½" (241mm) Straight



Blumenthal Forceps

Slightly curved forceps with large oval jaws and coarse teeth.

031141 Blumenthal Evacuation Forceps 13" (330mm)
20mm Jaws

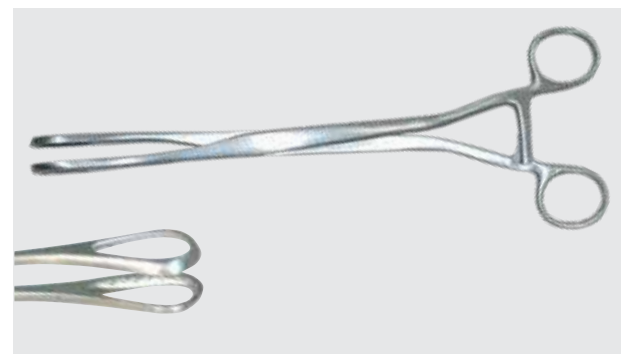

Saenger Forceps

Forceps with unique inner-diameter teeth within oval jaws.

031163 Saenger Ovum Forceps 11¼" (286mm) Curved

031164 Saenger Ovum Forceps 10¾" (273mm) Straight
with Ratchet

031165 Saenger Ovum Forceps 10½" (267mm) Curved
with Ratchet

031172 Saenger Ovum Forceps 13" (330mm) Straight
with Ratchet

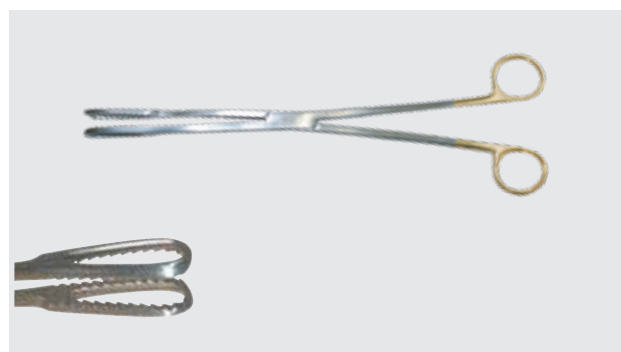

Jacobson Forceps

Slightly curved forceps, with coarse teeth, oval jaw and enlarged ring handles. With concave tip.

031142 Jacobson Evacuation Forceps 13" (330mm)
Large with 20mm Jaws



Boston Forceps

Straight forceps with large oval jaws and coarse teeth.

- 031156 Boston Evacuation Forceps 13½" (343mm)
27mm Jaws - High Fulcrum
- 031157 Boston Evacuation Forceps 13½" (343mm)
27mm Jaws - Low Fulcrum

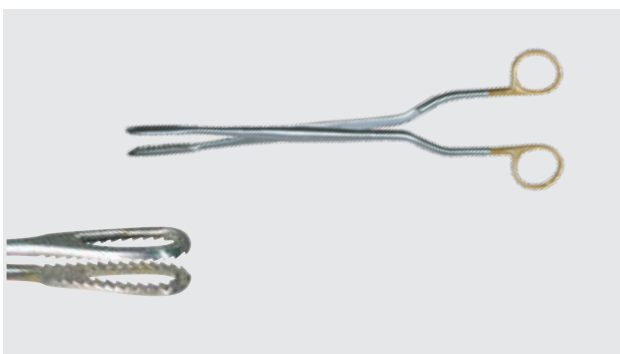

Meltzer Forceps

- 031143 Meltzer Evacuation Forceps 13" (330mm)
19mm Jaws



McClintock Forceps

Slightly curved with fine-tooth jaws.

- 031122 McClintock Ovum Forceps 9½"
(241mm) 14mm Jaws

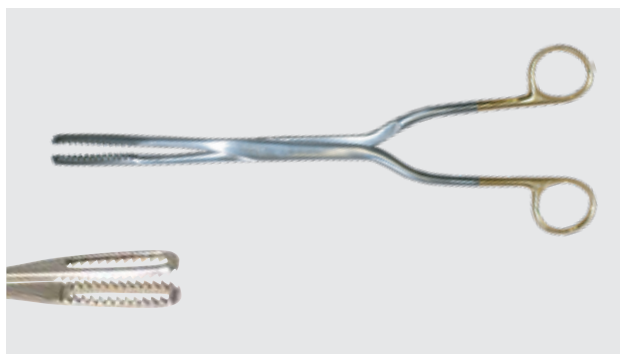

Fink Forceps

Slightly curved with jaws and concave tip.

- 031176 Fink Ovum Forceps 10½" (267mm)
13mm Jaws

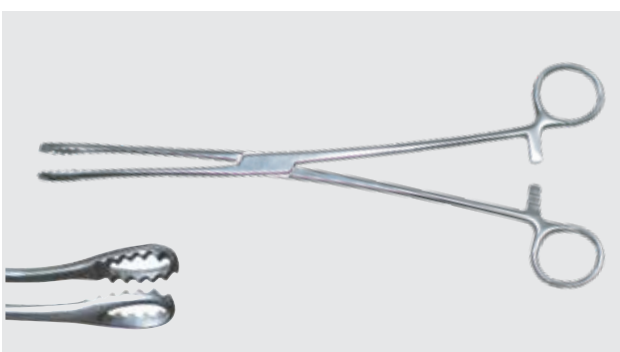

Lisa Forceps

- 031173 Lisa Forceps 10" (254mm)

MedGyn Placenta Forceps

Hern-Barret Placenta Forceps

Slightly curved placenta forceps with oval jaws.

- 031151 Hern-Barret Placenta Forceps 13" (330mm)
16mm Serrated Jaws
- 031152 Hern-Barret Placenta Forceps 13" (330mm)
16mm Smooth Jaws



Kelly Placenta Forceps

Slightly curved placenta forceps with serrated jaws.

- 031140 Kelly Placenta Forceps 12.5" (318mm)
19mm Serrated Jaws

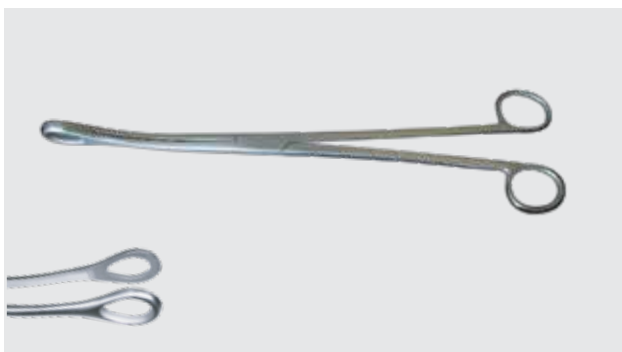

Hern-Kelly Placenta Forceps

Slightly curved placenta forceps with serrated jaws.

- 031145 Hern-Kelly 13" (330mm)
19mm Serrated Jaws



MedGyn Myoma Grasping Forceps

Myoma Grasping Forceps

Ideal for transcervical management of polyps and pedunculated myoma.

- 031210 Myoma Grasping Forceps 13" (330mm) 7mm Jaws
- 031211 Myoma Grasping Forceps 13" (330mm) 11mm Jaws
- 031212 Myoma Grasping Forceps 13" (330mm) 17mm Jaws



MedGyn Tissue Forceps

Ochsner Tissue Forceps

- 031169 Ochsner Tissue Forceps

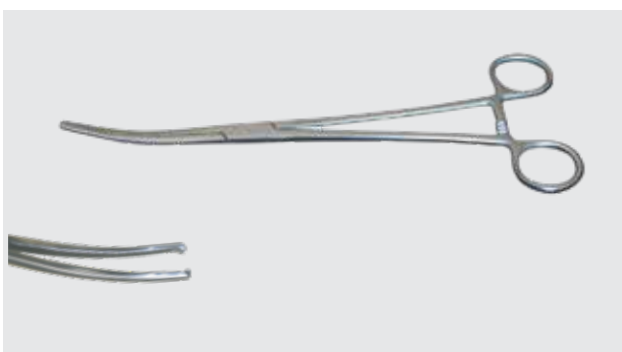



Baby Allis Tissue Forceps

- 031111 Baby Allis Forceps 5½" (140mm)
4x5 Teeth-Extra Delicate Jaws
- 031112 Baby Allis Forceps 5" (127mm)
4x5 Teeth-Extra Delicate Jaws



Adson Tissue Forceps

- 031196 Adson Tissue Forceps 4¾" (121mm)
1x2 Teeth



Tissue Forceps

- 031180 Tissue Forceps 8" (203mm) Small 1x2 Teeth
- 031181 Tissue Forceps 10" (254mm) Large 1x2 Teeth



MedGyn Tissue Forceps

Allis Tissue Forceps

- 031107 Allis Tissue Forceps 4" (104mm) 4x5 Teeth
- 031105 Allis Tissue Forceps 5" (127mm) 4x5 Teeth
- 031108 Allis Tissue Forceps 6" (152mm) 4x5 Teeth
- 031109 Allis Tissue Forceps 6" (152mm) 5x6 Teeth
- 031110 Allis Tissue Forceps 7½" (190mm) 5x6 Teeth
- 031103 Allis Tissue Forceps 9½" (241mm) 5x6 Teeth
- 031106 Allis Tissue Forceps 10" (254mm) 5x6 Teeth
- 031104 Allis Tissue Forceps 6" (152mm) 4x5 Teeth
with Angular Jaws
- 031101 Allis Tissue Forceps 6" (152mm) 5x6 Teeth
with Angular Jaws
- 031102 Allis Tissue Forceps 7¼" (184mm) 5x6 Teeth
with Angular Jaws

MedGyn Polyp Forceps

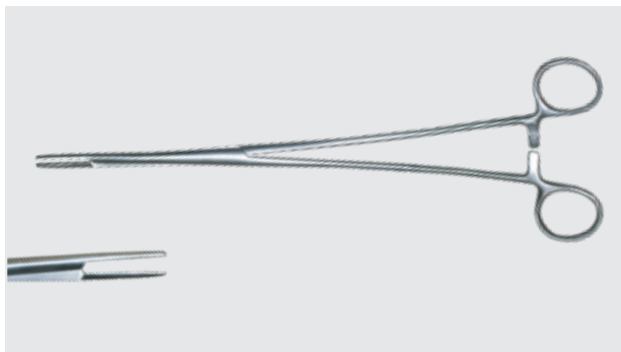

Polyp Forceps

031121 Polyp Forceps 10" (254mm) Narrow Jaws



Alligator Forceps

Perfect design for retrieval of IUDs, with hinged serrated jaws.

030112 Alligator Forceps 8" (203mm)

030112-11 Alligator Forceps 11" (279mm)

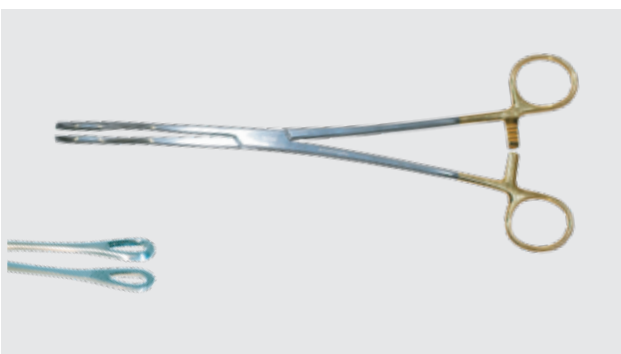

Foerster Dressing Forceps

031035 Foerster Dressing Forceps 9½" (241mm) Straight - Serrated Jaws

031037 Foerster Dressing Forceps 9½" (241mm) Straight - Smooth Jaws

031036 Foerster Dressing Forceps 9½" (241mm) Curved - Serrated Jaws

031038 Foerster Dressing Forceps 9½" (241mm) Curved - Smooth Jaws

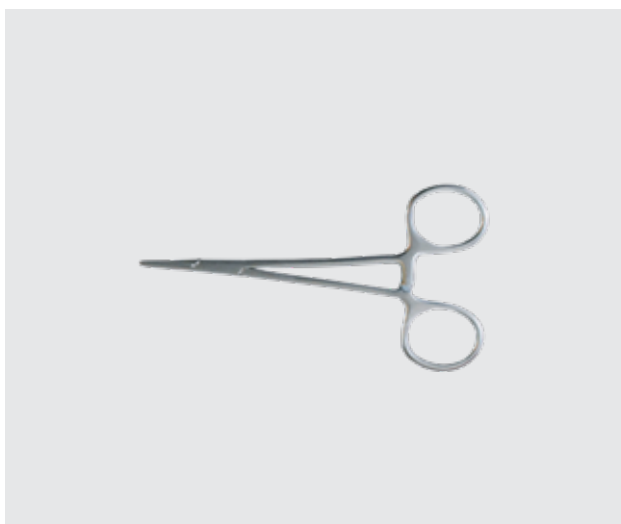

Halsted Mosquito Forceps

031113 Halsted Mosquito Hemostatic Forceps Straight 5" (127mm)

031114 Halsted Mosquito Hemostatic Forceps Straight with Delicate Teeth 5" (127mm)

031115 Halsted Mosquito Hemostatic Forceps Straight with 1x2 Teeth 5" (127mm)

031116 Halsted Mosquito Hemostatic Forceps Curved 5" (127mm)

031118 Halsted Mosquito Hemostatic Forceps Curved with Delicate Teeth 5" (127mm)

031119 Halsted Mosquito Hemostatic Forceps Curved with 1x2 Teeth 5" (127mm)

031116-ECO Halsted Mosquito Hemostatic Forceps Economy 5" (127mm)



Bozeman Uterine Dressing Forceps

- 031161 Bozeman Uterine Dressing 10½" (267mm) Straight
- 031162 Bozeman Uterine Dressing 10½" (267mm) Curved
- 031162-ECO Bozeman Uterine Dressing 10½" (267mm) Curved - Economy



Dressing Forceps

- 031186 Dressing Forceps 8" (203mm)
- 031187 Dressing Forceps 10" (254mm)

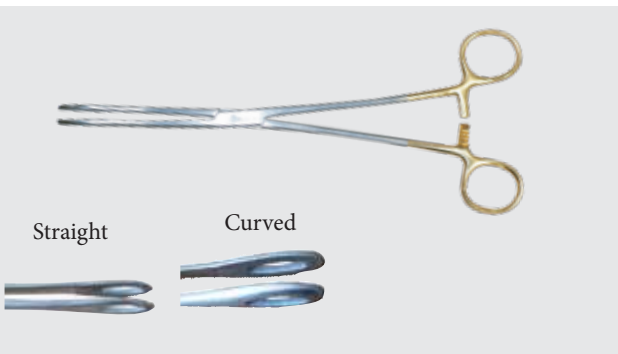

Fletcher Forceps

- 031014 Fletcher with Oval Jaws 9½" (241mm) Straight
- 031015 Fletcher with Oval Jaws 9½" (241mm) Curved



IUD Hooks

For IUD retrieval; available in single and double notch versions.

- 031306 IUD Hook 10" (254mm) Single Notch
- 031307 IUD Hook 10½" (265mm) Double Notch
- 031308 IUD Hook Universal 12½" (318mm)

MedGyn Long-Reach Instruments

Allis Tissue Forceps

031099 Allis Forceps 12" (305mm) 5x6 Teeth

031100 Allis Forceps 14" (356mm) 5x6 Teeth

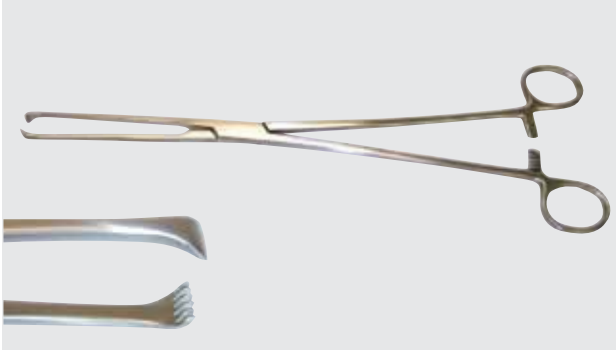

Babcock Tissue Forceps

031188 Babcock Tissue Forceps 12" (305mm)

031189 Babcock Tissue Forceps 14" (356mm)

031190 Babcock Tissue Forceps 18" (457mm)



DeBakey Tissue Forceps

031182 DeBakey Tissue Forceps 12" (305mm)

031183 DeBakey Tissue Forceps 14" (356mm)



Gemini Forceps

031192 Gemini Forceps 14" (356mm) Curved



Crile Wood Needle Holder

040085 Crile Wood Needle Holder 12" (305mm)

040086 Crile Wood Needle Holder 14" (356mm)

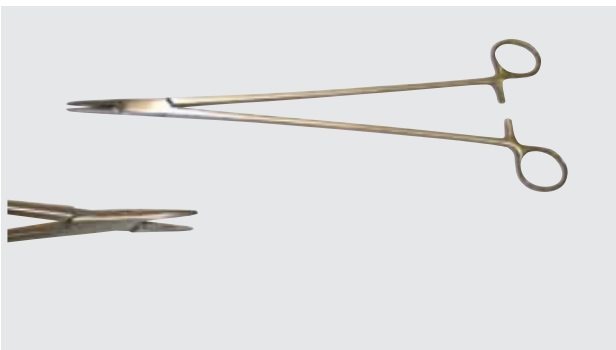

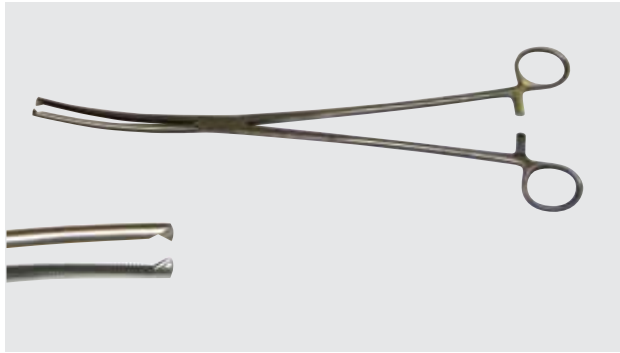

Rochester Ochsner Forceps

- 031184 Rochester Ochsner Forceps 12" (305mm) Curved
- 031185 Rochester Ochsner Forceps 14" (356mm) Curved



Clark Hysterectomy Forceps

- 031193 Clark Hysterectomy Forceps 12" (305mm) Curved
- 031194 Clark Hysterectomy Forceps 14" (356mm) Curved



Kocher Forceps

- 031195 Kocher Forceps Curved 14" (356mm)



Jorgenson Scissors

- 031177 Jorgenson Scissors 14" (356mm) Curved



Metzenbaum Scissors

- 040091 Metzenbaum Scissors Curved 14" (356mm)
- 040092 Metzenbaum Scissors Straight 14" (356mm)

MedGyn Hysterectomy Clamps

Hysterectomy ("Z")– Clamps

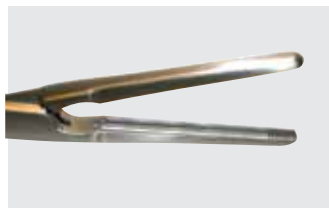

- | | | | |
|--------|---|--------|---|
| 040025 | Hysterectomy Clamp 8¼" (210mm) - Straight | 040047 | Hysterectomy Clamp 12" (305mm) - Strong Curve |
| 040026 | Hysterectomy Clamp 8¼" (210mm) - Slight Curve | 040048 | Hysterectomy Clamp 12" (305mm) - Angled |
| 040027 | Hysterectomy Clamp 8¼" (210mm) - Full Curve | 040055 | Hysterectomy Clamp 14" (356mm) - Straight |
| 040028 | Hysterectomy Clamp 8¼" (210mm) - Angled | 040056 | Hysterectomy Clamp 14" (356mm) - Slight Curve |
| 040035 | Hysterectomy Clamp 9½" (241mm) - Straight | 040057 | Hysterectomy Clamp 14" (356mm) - Strong Curve |
| 040036 | Hysterectomy Clamp 9½" (241mm) - Slight Curve | 040058 | Hysterectomy Clamp 14" (356mm) - Angled |
| 040037 | Hysterectomy Clamp 9½" (241mm) - Strong Curve | 040015 | Hysterectomy Clamp 16" (406mm) - Straight |
| 040038 | Hysterectomy Clamp 9½" (241mm) - Angled | 040016 | Hysterectomy Clamp 16" (406mm) - Slight Curve |
| 040045 | Hysterectomy Clamp 12" (305mm) - Straight | 040017 | Hysterectomy Clamp 16" (406mm) - Strong Curve |
| 040046 | Hysterectomy Clamp 12" (305mm) - Slight Curve | 040018 | Hysterectomy Clamp 16" (406mm) - Angled |

MedGyn Hysterectomy Forceps



Pean Hysterectomy Forceps - Straight

030999 Pean Hysterectomy Forceps Straight 8" (203mm)

Pean Hysterectomy Forceps - Curved

031000 Pean Hysterectomy Forceps Curved 8" (203mm)

MedGyn Hysterectomy Scissors

- | | | | |
|--------|---|--------|--|
| 041125 | Hysterectomy Scissors 9" (229mm) - Slight Curve | 041145 | Hysterectomy Scissors 12" (305mm) - Slight Curve |
| 041126 | Hysterectomy Scissors 9" (229mm) - Curve | 041146 | Hysterectomy Scissors 12" (305mm) - Curve |
| 041127 | Hysterectomy Scissors 9" (229mm) - Full Curve | 041147 | Hysterectomy Scissors 12" (305mm) - Full Curve |
| 041128 | Hysterectomy Scissors 9" (229mm) - Angled | 041148 | Hysterectomy Scissors 12" (305mm) - Angled |
| 041135 | Hysterectomy Scissors 10½" (267mm) - Slight Curve | 041155 | Hysterectomy Scissors 14" (356mm) - Slight Curve |
| 041136 | Hysterectomy Scissors 10½" (267mm) - Curve | 041156 | Hysterectomy Scissors 14" (356mm) - Curve |
| 041137 | Hysterectomy Scissors 10½" (267mm) - Full Curve | 041157 | Hysterectomy Scissors 14" (356mm) - Full Curve |
| 041138 | Hysterectomy Scissors 10½" (267mm) - Angled | 041158 | Hysterectomy Scissors 14" (356mm) - Angled |

MedGyn Scissors



Metzenbaum Scissors - Straight

- 041026 Metzenbaum 5" (127mm) - Standard Straight
- 041028 Metzenbaum 6" (152mm) - Standard Straight
- 041030 Metzenbaum 7" (178mm) - Standard Straight
- 041032 Metzenbaum 8" (203mm) - Standard Straight
- 041034 Metzenbaum 9" (229mm) - Standard Straight
- 041036 Metzenbaum 10" (254mm) - Standard Straight
- 041038 Metzenbaum 11" (279mm) - Standard Straight
- 041040 Metzenbaum 12" (305mm) - Standard Straight
- 041026-DEL Metzenbaum 5" (127mm) - Delicate Straight
- 041028-DEL Metzenbaum 6" (152mm) - Delicate Straight
- 041030-DEL Metzenbaum 7" (178mm) - Delicate Straight
- 041032-DEL Metzenbaum 8" (203mm) - Delicate Straight
- 041034-DEL Metzenbaum 9" (229mm) - Delicate Straight

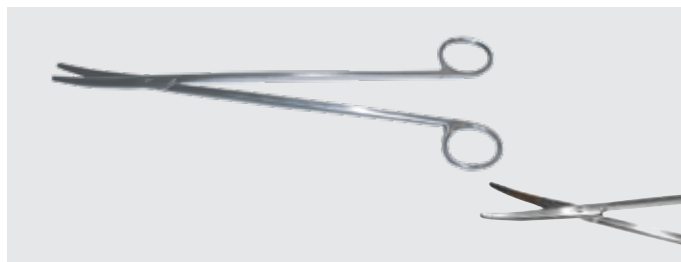

Metzenbaum Scissors - Curved

- 041025 Metzenbaum 5" (127mm) - Standard Curved
- 041027 Metzenbaum 6" (152mm) - Standard Curved
- 041029 Metzenbaum 7" (178mm) - Standard Curved
- 041031 Metzenbaum 8" (203mm) - Standard Curved
- 041033 Metzenbaum 9" (229mm) - Standard Curved
- 041035 Metzenbaum 10" (254mm) - Standard Curved
- 041037 Metzenbaum 11" (279mm) - Standard Curved
- 041039 Metzenbaum 12" (305mm) - Standard Curved
- 041025-DEL Metzenbaum 5" (127mm) - Delicate Curved
- 041027-DEL Metzenbaum 6" (152mm) - Delicate Curved
- 041029-DEL Metzenbaum 7" (178mm) - Delicate Curved
- 041031-DEL Metzenbaum 8" (203mm) - Delicate Curved
- 041033-DEL Metzenbaum 9" (229mm) - Delicate Curved



Operating Scissors - Straight

- 042000-S Straight Scissors 4½" (114mm) - Blunt/Blunt
- 042001-S Straight Scissors 4½" (114mm) - Sharp/Blunt
- 042002-S Straight Scissors 4½" (114mm) - Sharp/Sharp
- 042004-S Straight Scissors 5" (127mm) - Blunt/Blunt
- 042003-S Straight Scissors 5" (127mm) - Sharp/Blunt
- 042005-S Straight Scissors 5" (127mm) - Sharp/Sharp
- 042006-S Straight Scissors 5½" (140mm) - Blunt/Blunt
- 042007-S Straight Scissors 5½" (140mm) - Sharp/Blunt
- 042008-S Straight Scissors 5½" (140mm) - Sharp/Sharp
- 042009-S Straight Scissors 6" (152mm) - Blunt/Blunt
- 042010-S Straight Scissors 6" (152mm) - Sharp/Blunt
- 042011-S Straight Scissors 6" (152mm) - Sharp/Sharp
- 042012-S Straight Scissors 6½" (165mm) - Blunt/Blunt
- 042013-S Straight Scissors 6½" (165mm) - Sharp/Blunt
- 042014-S Straight Scissors 6½" (165mm) - Sharp/Sharp
- 042015-S Straight Scissors 7½" (191mm) - Sharp/Blunt
- 042016-S Straight Scissors 7½" (191mm) - Blunt/Blunt



Operating Scissors - Curved

- 042000-C Curved Scissors 4½" (114mm) - Blunt/Blunt
- 042001-C Curved Scissors 4½" (114mm) - Sharp/Blunt
- 042002-C Curved Scissors 4½" (114mm) - Sharp/Sharp
- 042004-C Curved Scissors 5" (127mm) - Blunt/Blunt
- 042003-C Curved Scissors 5" (127mm) - Sharp/Blunt
- 042005-C Curved Scissors 5" (127mm) - Sharp/Sharp
- 042006-C Curved Scissors - 5½" (140mm) - Blunt/Blunt
- 042007-C Curved Scissors 5½" (140mm) - Sharp/Blunt
- 042008-C Curved Scissors 5½" (140mm) - Sharp/Sharp
- 042009-C Curved Scissors 6" (152mm) - Blunt/Blunt
- 042010-C Curved Scissors 6" (152mm) - Sharp/Blunt
- 042011-C Curved Scissors 6" (152mm) - Sharp/Sharp
- 042012-C Curved Scissors 6½" (165mm) - Blunt/Blunt
- 042013-C Curved Scissors 6½" (165mm) - Sharp/Blunt
- 042014-C Curved Scissors 6½" (165mm) - Sharp/Sharp
- 042015-C Curved Scissors 7½" (191mm) - Sharp/Blunt

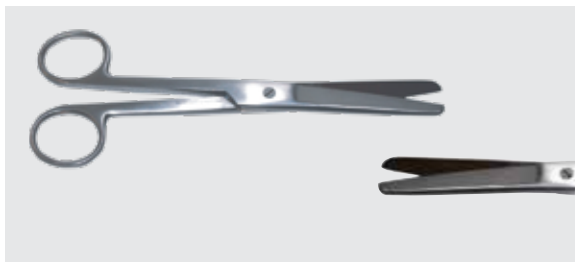

Doyen Scissors

- 041075 Doyen Scissors 7" (178mm) - Curved/Smooth
- 041076 Doyen Scissors 7" (178mm) - Straight/Smooth
- 041077 Doyen Scissors 7" (178mm) - Curved/Serrated
- 041078 Doyen Scissors 7" (178mm)- Straight/Serrated



IUD Scissors

- 041010 IUD Scissors Curved 10" (254mm)



Mayo Scissors

- 041061 Straight Mayo Scissors 5½" (140mm)
- 041063 Straight Mayo Scissors 6¾" (171mm)
- 041070 Straight Mayo Scissor 8" (203mm)
- 041067 Straight Mayo Scissors 9" (229mm)
- 041071 Straight Mayo Scissor 10¼"(260mm)
- 041069 Straight Mayo Scissors 11" (279mm)
- 041060 Curved Mayo Scissors 5½" (140mm)
- 041062 Curved Mayo Scissors 6¾" (171mm)
- 041064 Curved Mayo Scissors 8" (203mm)
- 041066 Curved Mayo Scissors 9" (229mm)
- 041068 Curved Mayo Scissors 11" (279mm)

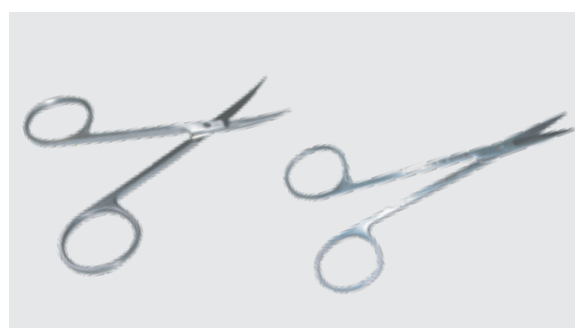

Iris Scissors

- 041100 Iris Scissors 3½" (89mm), 20mm Blades Delicate Curved
- 041101 Iris Scissors 3½" (89mm), 20mm Blades Delicate Straight
- 041102 Iris Scissors 3¾" (95mm), 14mm Blades Curved Ribbon Type
- 041103 Iris Scissors 3¾" (95mm), 14mm Blades Straight Ribbon Type
- 041104 Iris Scissors 4½" (114mm) Angled on Side
- 041105 Iris Scissors 4½" (114mm) Curved
- 041106 Iris Scissors 4½" (114mm) Curved Sideways
- 041107 Iris Scissors 4½" (114mm) Straight



Kelly-Adson Scissors

- 041085 Kelly-Adson 6¼" (159mm) Smooth/Straight
- 041086 Kelly-Adson 6¼" (159mm) Serrated/Straight
- 041087 Kelly-Adson 6¼" (159mm) Smooth/Curved



Potts-Smith Scissors

- 041015 Potts-Smith Scissors 7" (178mm), 13mm Blades, Delicate - Angled 25°
- 041016 Potts-Smith Scissors 7" (178mm), 13mm Blades, Delicate - Angled 45°
- 041017 Potts-Smith Scissors 7" (178mm), 13mm Blades, Delicate - Angled 60°
- 041018 Potts-Smith Scissors 7½" (191mm), 20mm Blades, Delicate - Angled 25°
- 041019 Potts-Smith Scissors 7½" (191mm), 20mm Blades, Delicate - Angled 45°
- 041020 Potts-Smith Scissors 7½" (191mm), 20mm Blades, Delicate - Angled 60°



Lister Scissors

- 041050 Lister Bandage Scissors 3½" (89mm) Extra Fine
- 041051 Lister Bandage Scissors 4½" (114mm) Extra Fine
- 041052 Lister Bandage Scissors 5½" (140mm) Extra Fine
- 041053 Lister Bandage Scissors 7¼" (184mm) Extra Fine
- 041054 Lister Bandage Scissors 8" (203mm) with One Larger Finger Ring



Littauer Scissors

- 041088 Littauer Stitch Scissors 4½" (114mm) Light
- 041089 Littauer Stitch Scissors 5½" (140mm) Standard
- 042099-ECO Littauer Stitch Scissor 4½" (114mm) Economy



Sweet Scissors

- 041096 Sweet Scissors 8½" (216mm) Angled on Flat



Spencer Scissors

- 041095 Spencer Stitch Scissors 3½" (89mm) Delicate

MedGyn Needle Holders

Webster Needle Holder

- 040075 Webster Needle Holder 5" (127mm) Serrated Jaws
040076 Webster Needle Holder 5" (127mm) Smooth Jaws



Mayo-Hegar Needle Holder

- 040093 Mayo-Hegar Needle Holder 5" (127mm) Serrated
040094 Mayo-Hegar Needle Holder 6" (152mm) Serrated
040095 Mayo-Hegar Needle Holder 7" (178mm) Serrated
040096 Mayo-Hegar Needle Holder 8" (203mm) Serrated



Olsen-Hegar Needle Holder/Scissors

- 040097 Olsen-Hegar Needle Holder/Scissors 4¾" (121mm) Serrated Extra Delicate
040098 Olsen-Hegar Needle Holder/Scissors 4¾" (121mm) Smooth Extra Delicate
040099 Olsen-Hegar Needle Holder/Scissors 5½" (140mm) Serrated
040100 Olsen-Hegar Needle Holder/Scissors 6½" (165mm) Serrated
040101 Olsen-Hegar Needle Holder/Scissors 7¼" (184mm) Serrated

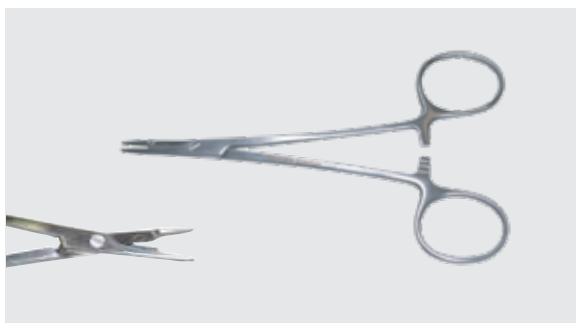

Heaney Needle Holder

- 040071 Heaney Needle Holder 8½" (216mm) Curved Jaws



Mathieu Needle Holder

- 040072 Mathieu Needle Holder 5½" (140mm) w/Spring Handles
040073 Mathieu Needle Holder 6¼" (159mm) w/Spring Handles
040074 Mathieu Needle Holder 7½" (191mm) w/Spring Handles

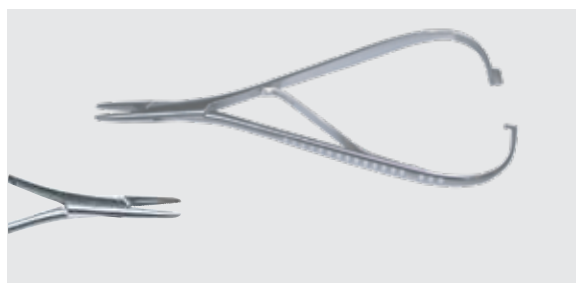

Crile-Wood Needle Holder

- 040081 Crile-Wood Needle Holder 6" (152mm)
040082 Crile-Wood Needle Holder 7" (178mm)
040083 Crile-Wood Needle Holder 8" (203mm)
040084 Crile-Wood Needle Holder 9" (229mm)
040087 Crile-Wood Needle Holder 10½" (267mm)

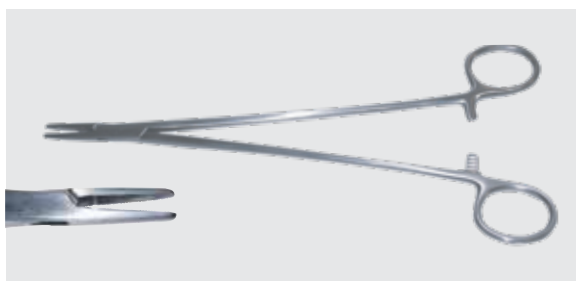



Miscellaneous Products

- 040004 Emesis Basin Medium 8" (203mm)
- 040005 Emesis Basin Large 10" (254mm)
- 040003 Emesis Basin Small 6" (152mm)
- 040008 Iodine Cup 6oz
- 040001 Medicine Cup (2 oz.)
- 040009 Instrument Cleaner 8oz Bottle
- 040000 Instrument Lubricant Spray - 8oz
- 040010 Instrument Stain Remover 3oz
- 040002 Instrument Steel Tray - 12 $\frac{1}{4}$ " X 7 $\frac{5}{8}$ " X 2 $\frac{1}{8}$ "
(Graham 3259)

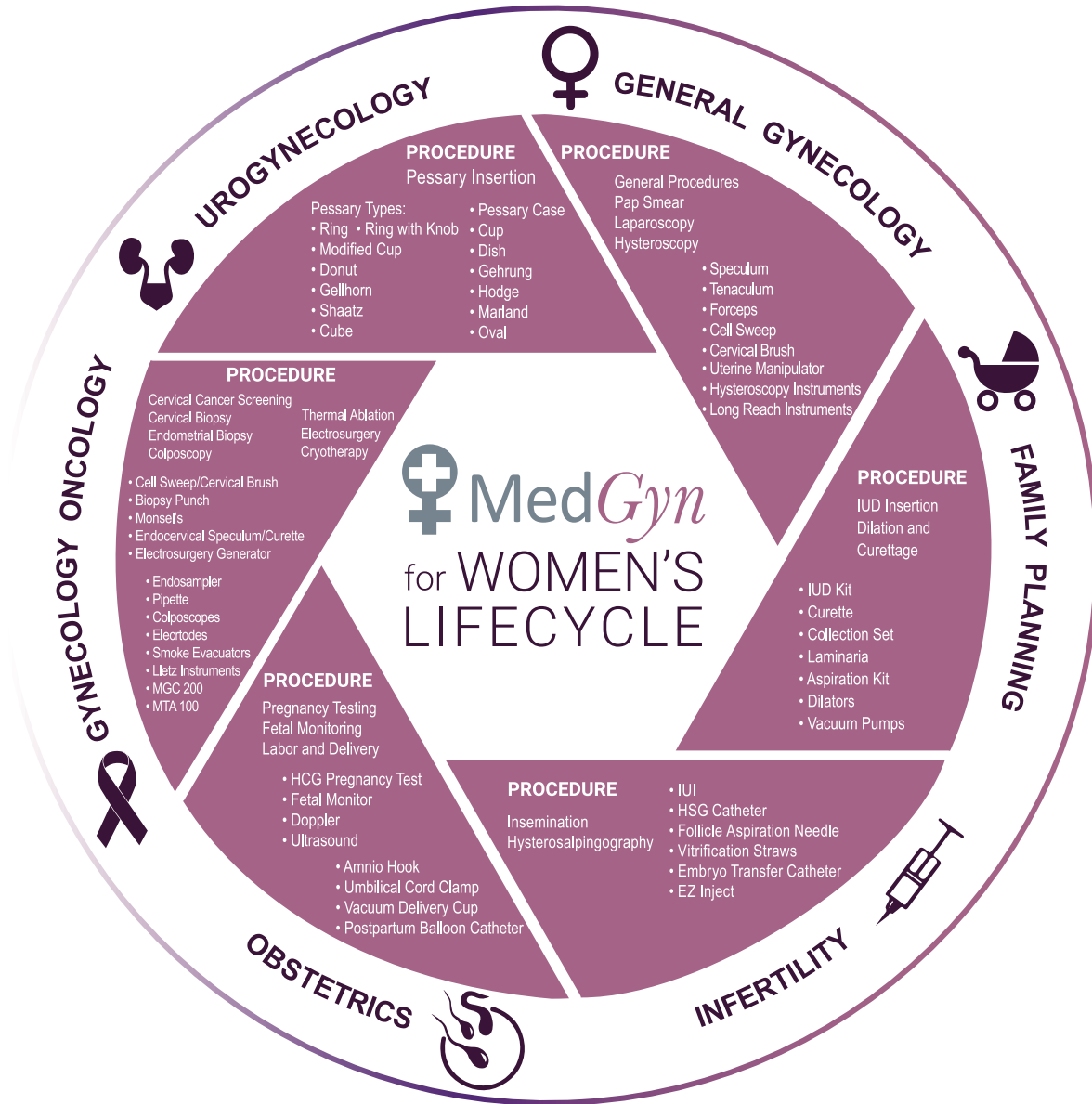

800 Pasquinelli Dr. Westmont, IL 60559
 Main: 1.630.627.4105 Toll-Free: 1.800.451.9667
 Fax: 1.630.627.0127 Email: info@medgyn.com
 medgyn.com

